



2021-1

KURUMSAL

Dortek markası 2003 yılında “Türkiye’nin ilk kapı markası” olarak kurulmuştur. Faaliyete başladığı günden bu yana Dortek markası patentli Monoblok teknolojisi ve Ultra-Viyole Lake uygulamalarında öncü olarak kapı teknolojileri ve kapı mimarisi alanlarında ilklere imza atmıştır. Faaliyete başladığı günden bu yana Dortek sürekli gelişen ürün gamı, üretim teknolojileri ve uygulama çözümleri ile kapı üretim sektöründe fark yaratmak ve kalite standartlarını bir üst seviyeye taşımayı hedeflemiştir. Bireysel pazarın yanı sıra proje danışmanlığı ve çözüm ortaklığı ile çeşitli mimari projelere özel mühendislik çözümleri ve kapı uygulamaları sunan Dortek 2021 yılına kadar bir çok mimari projenin (AVM, Okul, Hastane, Plaza, vb.) çelik kapı, yangın kapısı ve benzeri performans kapılarını tedarik etmiş ve çeşitli kapı sistemleri ve açılım çözümleriyle çözüm ortağı olmuştur.

Genel merkezi İstanbul’da olan Dortek’in 30.000m2 alana yayılmış olan üretim tesisleri Kastamonu’da bulunmaktadır. Ayda 30.000 adete kadar çıkabilen üretim kapasitesi ile Türkiye’nin, kapı üretiminde en büyük ve teknolojik anlamda en kapsamlı, üretim tesisi olma özelliğini taşımaktadır. Son teknoloji makinelerden oluşan makine parkında UV (Ultra Viole) Lake, PVC, doğal ve endüstriyel ahşap üretim hatları ile tam otomatik üretim yapılabilmektedir. Dortek markası, markayı ve teknolojileri hep bir adım ileriye taşımak için çalışan, alanında uzman Ar-Ge ekibi ve çeşitli projelere özel çözüm ortaklığı sunan proje satış ve geliştirme mühendislerinin yanı sıra Türkiye’nin ve dünya’nın çeşitli yerlerine yayılan bayileri ile bulunduğu her yerde hizmet anlayışında fark yaratarak kalite standartlarının belirleyicisi olmayı hedeflemektedir.

CORPORATE

Dortek is Turkey's first and leading door brand that specializes in architecture, design, construction, and sale of doors since 2003. Dortek became the pioneer brand in Turkey to use manufacturing technologies such as fully automatic production with UV (Ultra-Violet) Lacquer and Monoblock door production and has differentiated itself from competitors by achieving numerous breakthroughs in the field of door manufacturing. Dortek aims to make a difference in the field by improving their quality standards to a higher level with each of their innovations. Dortek's constantly developing product range and production technologies come with professional application solutions by their team of engineers who specialize in the application methods of different doors and problem resolution in large-scale construction projects. Dortek also offers specialized engineering support for various architectural projects of various scales. Their project consultancy varies from solution providers to individual market distribution and applications, in which Dortek provides a wide range of product lines such as steel doors, fire doors, and similar performance doors (Shopping Malls, Schools, Hospitals, Private Projects, etc.) and so on.

Dortek's headquarters are located in Istanbul, and their production facilities are built on 30.000m² in Kastamonu. Kastamonu Dortek Facilities have a production capacity of up to 30,000 units per month, which earns them the title of Turkey's largest and most technologically comprehensive production facility of door production. With a machine park with fully automatized UV (Ultra Violet) Lacquer, PVC, natural, and industrial wood production lines, the Kastamonu Dortek facility has state-of-the-art machinery and lines of production. Dortek brand provides service wherever it is located, with its R&D team, who are experts in their fields, and project sales and development engineers who always work to take the brand and technologies one step further, as well as project sales and development engineers that offer special solution partnerships for various projects, as well as dealers in various parts of Turkey and the world. Dortek aims to be the determinant of quality standards by making a difference in its understanding.



ADEN DENEYİMİ

Dortek, kapıda deneyimin adı ve sektörünün en kıdemlisi, kapı alanındaki bu deneyiminin yeni ürünlerini sizlere gururla sunar. Kolay erişim ve hızlı fabrika üretim-teslim ürünlerinize, Dortek kalite ve güvencesi ile ulaşabilmeniz için bu yeni seriyi yarattık. Kurumsal ihtiyaçlarınıza uygun, yeni çağın ve marketin getirdiği yeniliklere, sizin ve kurumunuzun adapte olabilmesi için tüm şartlar hazır.

Ulaşılabilirlik ve kaliteyi bir arada sunan yeni Aden serisinde, ihtiyaçlarınıza yönelik size özel hızlı ve güvenilir çözümler bulunmaktadır. Sunulan minimal ve zarif tasarımlardaki yaklaşım anlayışını, Aden deneyiminizin her aşamasında hissedeceksiniz.

Halihazırda onlarca başarılı model serisi bulunan Dortek, daha özel çözümleri, daha özel başlıklar altında topluyor ve yeni seriler topluluğunun ilkinin ortaya koyuyor. Mevcut model serilerimizden farklı olarak, yeni ürün tasarımlarından fazlası. Satın alma sürecinizin en başından en sonuna kadar, gelişen yeni ihtiyaçlarınıza cevap veren ve size özel olan, bambaşka bir deneyime hazır olun.



Size özel ihtiyaçlarımız, size özel çözümler gerektirir. Aden, sizlere pratikliği ve zarafeti, tavizsizce ve rekabetsiz olarak sunuyor.

ADEN EXPERIENCE

Dortek, which is the name of the experience in the door and the most senior in the sector, proudly presents you the new products of this experience in the door field. With Dortek quality and assurance, we created this new series for you to have easy access and fast factory production-delivery products. All the conditions are now ready for you and your institution to adapt to the innovations brought by the new era and the market in convenience with your corporate needs.

There are fast and reliable solutions tailored for your needs at Aden series which is offering attainableness and quality together. At every stage of your Aden experience, you will feel the approach of this proffered minimal and stylish designs.

Dortek, which already has tens of successful model series, collects special solutions under special confidential titles and reveals the first of the new series. More than just new product designs, unlike our current model lines. Get ready for a totally different experience that meets your needs and is completely unique to you, from the beginning to the end of the purchasing process.

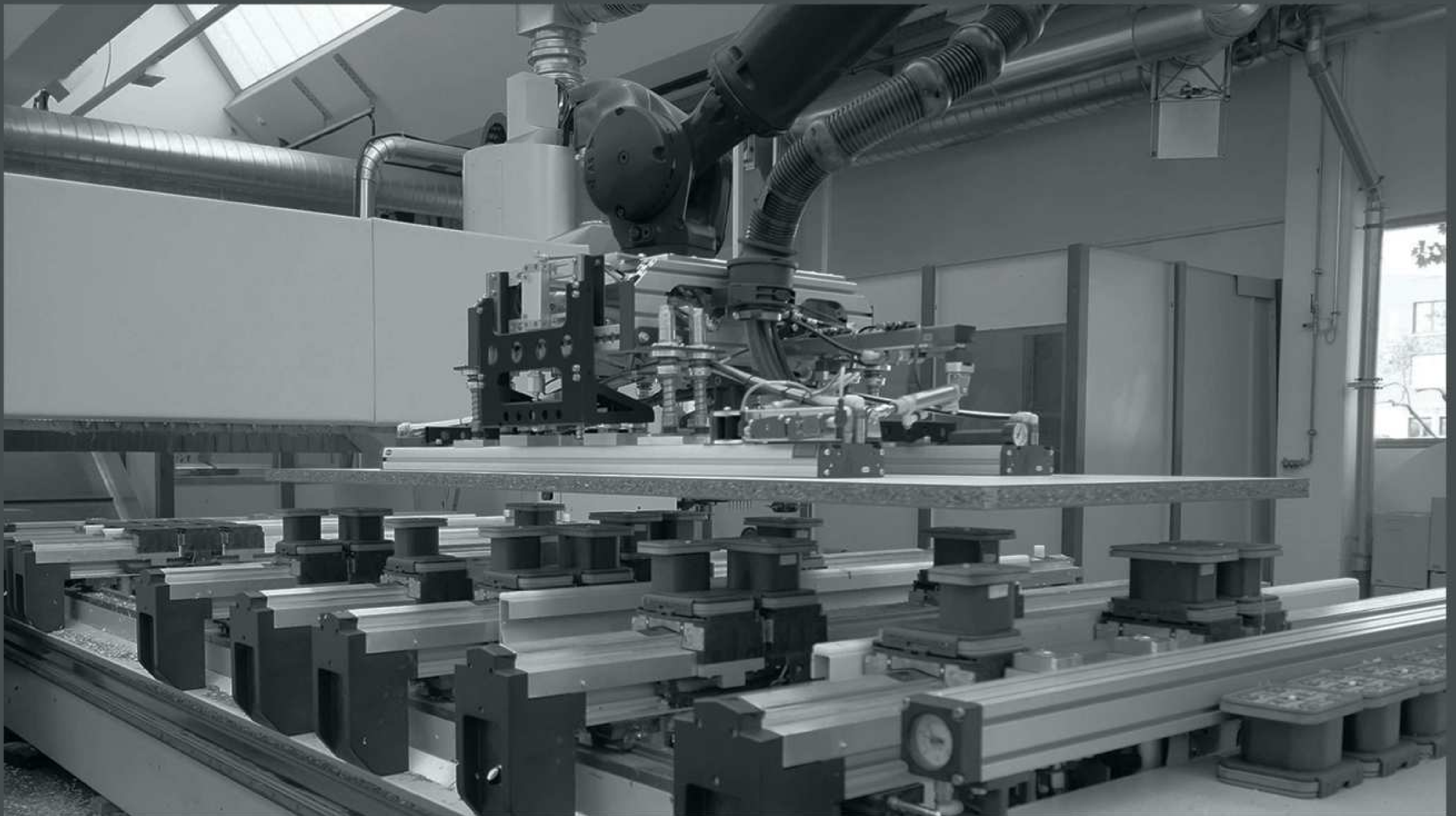

Your specific needs require private solutions. Aden presents you the practicability and elegance with uncompromising and noncompetitive.

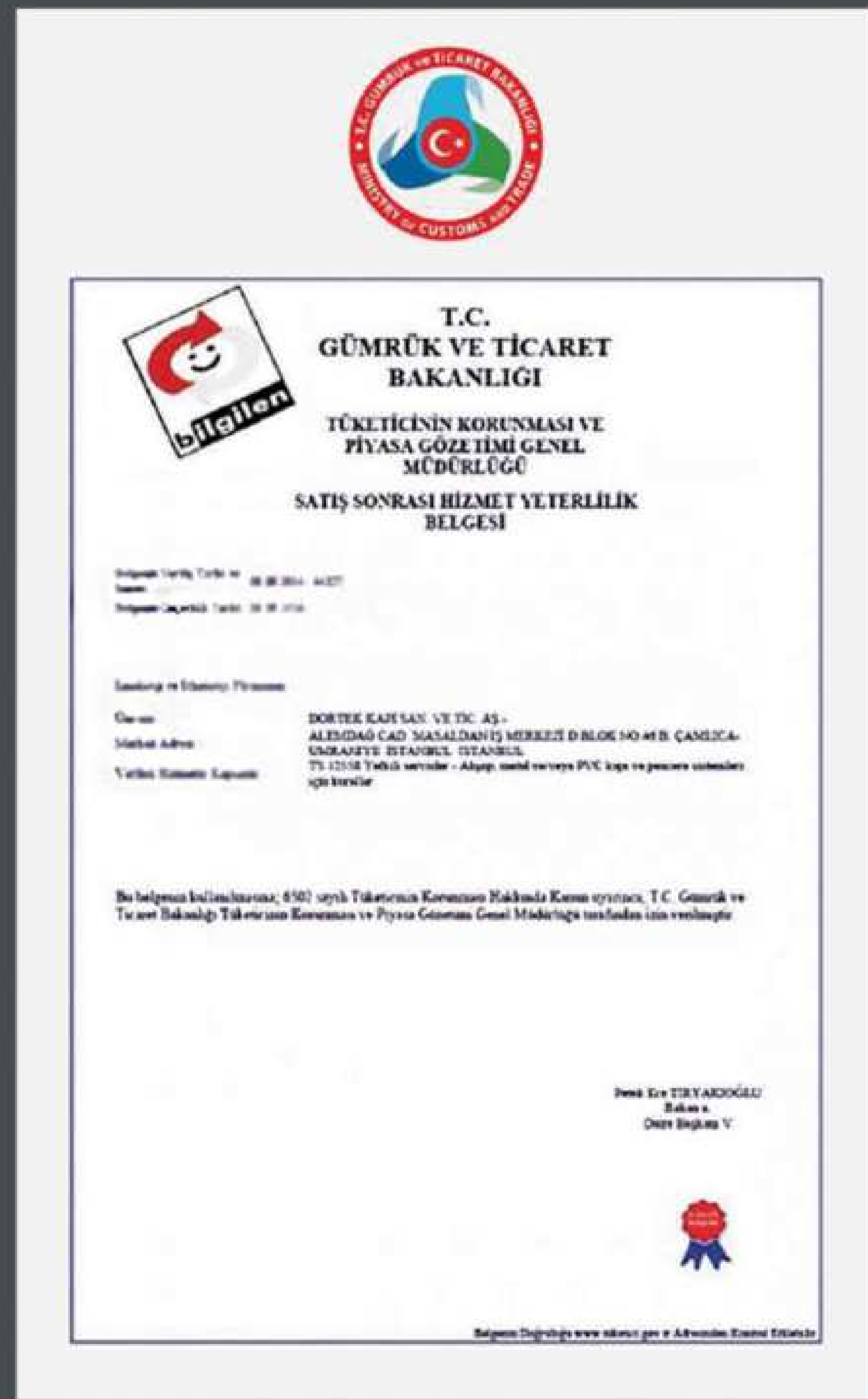
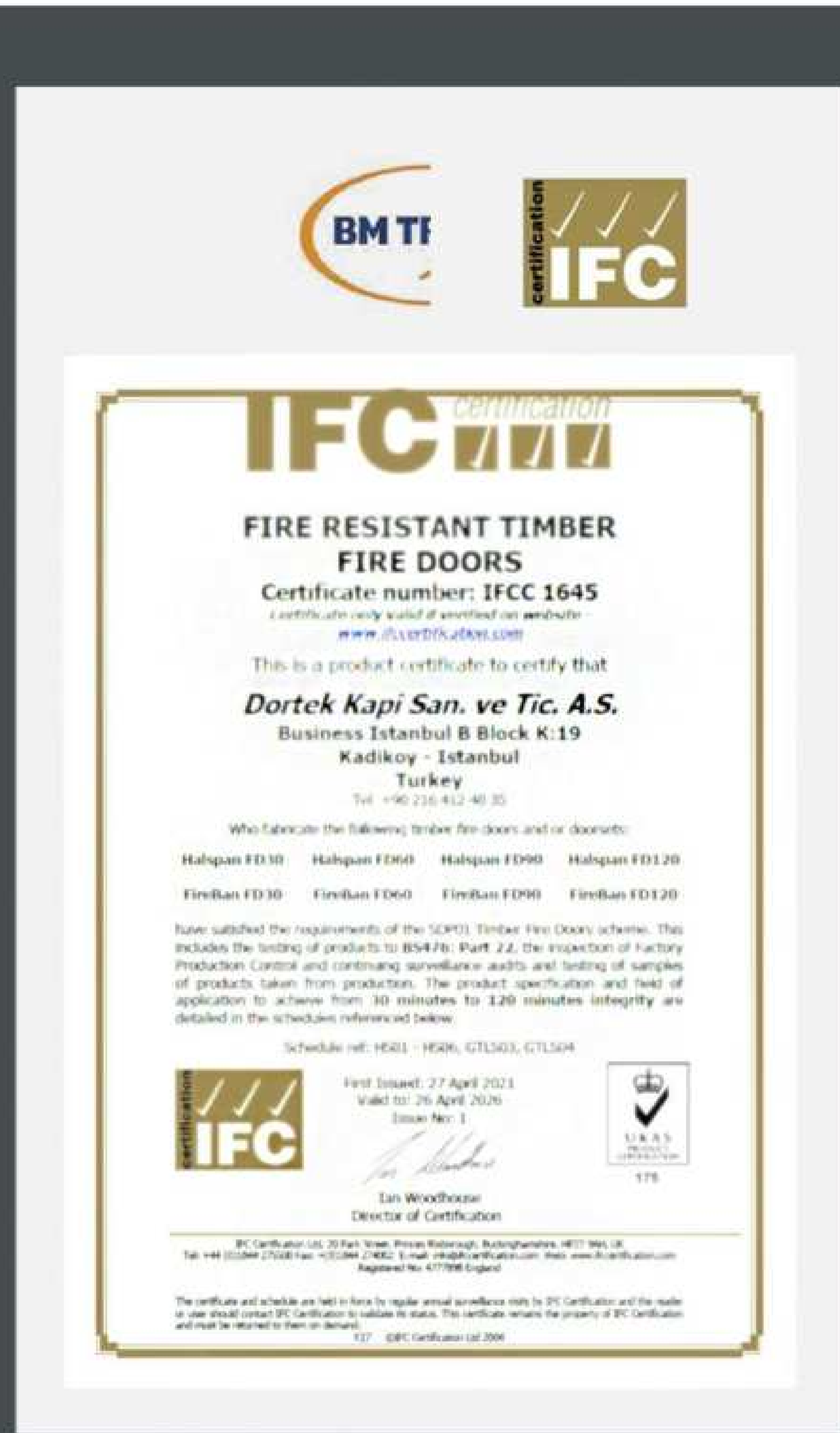



TÜRK STANDARTLARI ENSTİTÜSÜ
TSE-MYB
HİZMET YETERLİLİK BELGESİ

Belge No: 224976/0104
Belge Tarihi: 16.03.2014
Belge Durumu: 16.03.2014
Personel Adı: DORTEK KAPI SANAYİ VE TİCARET A.Ş.
Personel Adresi: ALEMDAĞ CAD. NO:46 D BLOK K 1 B ÇAMLIÇA - İSTANBUL - TÜRKİYE
Personel Yetki No: 8842402787
Belge No: 4802402787

Verilen Hizmetin Kapsamı:

1. 35 1267 01-01 2012 YETKİLİ SERVİSLER - ANKAP VEYA METAL MOBİL YA İÇİN - KURALLAR STANDARTINA UYGUN HİZMET VEREN KAPILAR, ANKAP VEYA METAL MOBİL YA HİZMET VEREN
"DORTEK KAPI SANAYİ VE TİCARET A.Ş. YENİ PAZAR (2013M4)"
(16.12.2013) (DORTEK) (MARKA)
2. 35 1208 01-01 2012 YETKİLİ SERVİSLER - ANKAP, METAL VEYA PVC KAPILAR VE PENCERE BİTEMLERİNİN KURALLAR STANDARTINA UYGUN HİZMET VEREN KAPILAR, ANKAP, METAL VEYA PVC KAPILAR VE PENCERE BİTEMLERİNİN UYGUN
"DORTEK KAPI SANAYİ VE TİCARET A.Ş. YENİ PAZAR (2013M4)"
(16.12.2013) (DORTEK) (MARKA)

23.08.2014
Genel Müdür
KASTAMUNU İZGÜNLEME WİCİNE



kiwa
KONFORMİTE GÜVENLÜĞÜ

ATTESTATION OF CONFORMITY
Certificate Number: 1405.MTS.001

DORTEK KAPI SANAYİ VE TİCARET A.Ş.
Baraj Yolu İnönü Mavi Kestane - Türkiye

Product: Monoblock door with frame and jamb
Model: 40 mm and 45 mm thickness

The above-mentioned product which has been tested according to the following specifications meets the basic requirements MEYER Product Certification procedures.

On the basis of samples taken from manufacturing site for testing it is determined that the noise elimination efficiency is up to 42 dB.

Reference Report No: 1405.MTS.001
Reference Product Approval Report: 199-000000-001
Rev: 01
Certificate Valid Until: 22.08.2015

This certificate has been issued by MEYER based on the samples taken from manufacturing site for testing and certification purposes. The manufacturer is hereby given the right to use the MEYER-TESTED Logo on the above-mentioned product.

23.08.2014
Genel Müdür
Belge No: 1405

TESTED
Noise Elimination
Efficiency up to 42 dB
MEYER

Meyer Group International Personnel A.Ş.
1108 9. Cad. No: 41 Tuzluca-Tuzluca/Tunceli
Tel: +90 312 401 70 70 Fax: +90 312 401 70 71
Meyer Group A.Ş. - Meyer Group A.Ş. A.Ş.
Meyers certificate papers



SERTİFİKA
CERTIFICATE 证书 ZERTIFIKAT प्रमाण-पत्र CERTIFICATO

dor tek

DORTEK KAPI SANAYİ VE TİCARET A.Ş.

MERKEZ: ALEMDAĞ CAD. NO:46 D BLOK K 1 B ÇAMLIÇA - İSTANBUL - TÜRKİYE
FABRİKA: BARAJ YOLU İNÖNÜ MAVİ KEŞTANE - KASTAMONU - TÜRKİYE

MONOBLOK DOLGU TEKNOLOJİSİ İLE ÜRETİLEN KAPI, PENCERE, MOBİLYA, MOBİLYA ÖNCESİ DEKORASYON MALZEMELERİ VE PETEK DOLGULU KAPILARIN TASARIMI, ÜRETİMİ, SATIŞI, PAZARLAMASI, UYGULAMASI VE SATIŞ SONRASI HİZMETLER
Kapsamında

OHSAS 18001:2007
by Sağlık ve Güvenlik Yönetim Sistemi Standardına uygun bir sistem kurmuştur.

Genel Müdür

MEYER

Meyer Group International Personnel A.Ş.
1108 9. Cad. No: 41 Tuzluca-Tuzluca/Tunceli
Tel: +90 312 401 70 70 Fax: +90 312 401 70 71
www.meyer.com.tr / www.meyer.com.tr

Sertifika Son Kullanma Tarihi: 23 Ağustos 2015-01-01

CERTIFICATES



KALİTE

En temel değerlerimizden biri de müşterilerimize taahhüt ediyor olduğumuz yüksek kalite standartlarıdır. Dortek ürünlerinde kullanılan tüm bileşenler, yılların ortaya koyduğu deneyimle, titizlikle seçilir. Kullanılan ahşap lif levha, astar, boya, kaplamalar, aksesuarlar ve diğer bileşenler, Dortek kalite çizgisine paralel olacak şekilde Avrupa Birliği normlarına uygun, sertifikasyonları tamamlanmış tedarikçilerden temin edilir ve DIN normlarında olmasına özellikle dikkat edilir. Ürün geliştirme çalışmalarında, üretilen her yeni ürün, yaşlandırma deneylerine tabi tutulur. Hizmete sunulmadan önce kalite kontrol süreçleri özenle takip edilir. Keşif, ölçü, demontaj ve montaj hizmetlerini satışın ayrılmaz bütünlüğü içerisinde tamamlayan Dortek'in en önemli ilkesi, müşteri memnuniyetini üst düzeyde sağlamaktır. Kaliteye olan tutkumuzla, sizlere bir üründen çok daha fazlasını sunuyoruz. Korumak, konfor sağlamak, bir tarzı ifade etmek ve değer yaratmak için tasarlanmış ürün ve hizmetler. Bizden bekleyebileceğiniz bunlardır.

QUALITY

One of our most fundamental values is the high quality standards that we are committed to our customers. All components used in Dortek products are meticulously selected with years of experience. The wood fiber board, lining, paint, coatings, accessories and other components used are supplied from certified suppliers compliant with European Union norms in line with the Dortek quality line and pay particular attention to being in DIN norms. In product development studies, every new product produced is subjected to aging tests. Quality control processes are followed carefully before being submitted to the service. The most important principle of Dortek, which completes discovery, measurement, disassembly and assembly services within the integral part of sale, is to provide customer satisfaction at a high level. With our passion for quality, we offer you far more than a product. Products designed to protect, provide comfort, express style and create value services. These are the things you can expect from us.

13-15



MODEL ÖN İZLEMELERİ

Serilerde uygulanabilen tüm modellere kısa bir genel bakış. 18 farklı modelden oluşan Aden kapıları, tercih edeceğiniz malzeme tipine göre polimerik veya lake olmak üzere iki farklı yüzey bitim malzemesinden biri ile tamamlanıyor.

MODEL PREVIEWS

An overview of all applicable models in the series. Aden doors, which consist of 18 different models to choose are completion with two different finishing surface materials as polymeric or lacquered.



VERITAS MODEL SERİSİ

Düz ve camlı olmak üzere iki farklı modelden oluşan bu seride fuga veya profil detayı olmaksızın sade ve şık bir görünüm elde edilir. Veritas modelleri ile her zevke hitap edebilir veya farklı tasarımlara uyum sağlayabilirsiniz.

VERITAS MODEL SERIES

In this series, which includes two different models as flat and glazed doors, you can get a simple and stylish look without any joint or profile details. With Veritas models, you can pleasing to all tastes or you can adapt to different designs.

POLİMERİK / POLYMERIC

Aden polimerik kaplama ürünleri, farklı renk ve desenlerden oluşan toplamda altı ayrı seçenekte sunulur. Lamine ahşap ve renk kaplama uygulamaları ile yüksek mukavemetli yoğunlukta üretilir. Bu özelliği sayesinde darbe ve çizilmelere karşı güçlü dayanıma sahiptir.

Aden polymeric veneer products presents six options with different colors and patterns. Polymeric models produced in high strength density with laminated wood veneer and color coating applications. Products has strong resistance against impacts and scratches because of this feature.

LAKE / LACQUERED

Aden lake boyalı ürünleri, iki farklı renk seçeneği ile sunulur. Mat ve ipeksi yüzeyi ile zarif bir görünüme sahiptir. Ahşap üzerine uygulanan astar katları, homojen ve boyanın tutunmasına uygun, pürüzsüz bir yüzey elde edilmesini sağlar ve sizlere lakenin ihtişamını sunar.

Aden lacquer products presents two different colors options. With matt and flossy surface products have elegant appearance. Lining coats applied on wood provide a smooth surface that is homogeneous and suitable for the adhesion of lacquer and offers you the magnificence of the lacquer.



PONTE MODEL SERİSİ

Farklı desen ve şekillerde yaratıcı modern tasarımlara yer verilen bu seride, 10 farklı model sunulmakta. Minimal detaylar ile oluşturulan seçeneklerden konsept ve tarzınıza uygun bir tercih yapabilirsiniz.

PONTE MODEL SERIE

In this series, which includes creative modern designs in different patterns and shapes with presented 10 different models. You can make a choice that suits your concept and style from created options with minimal details.

POLİMERİK / POLYMERIC

Aden polimerik kaplama ürünleri, farklı renk ve desenlerden oluşan toplamda altı ayrı seçenekte sunulur. Lamine ahşap ve renk kaplama uygulamaları ile yüksek mukavemetli yoğunlukta üretilir. Bu özelliği sayesinde darbe ve çizilmelere karşı güçlü dayanıma sahiptir.

Aden polymeric veneer products presents six options with different colors and patterns. Polimeric models produced in high strength density with laminated wood venner and color coating applications. Products has strong resistance against impacts and scratches because of this feature.

LAKE / LACQUERED

Aden lake boyalı ürünleri, iki farklı renk seçeneği ile sunulur. Mat ve ipeksi yüzeyi ile zarif bir görünüme sahiptir. Ahşap üzerine uygulanan astar katları, homojen ve boyanın tutunmasına uygun, pürüzsüz bir yüzey elde edilmesini sağlar ve sizlere lakenin ihtişamını sunar.

Aden lacquer products presents two different colors options. With matt and flossy surface products have elegant appearance. Lining coats applied on wood provide a smooth surface that is homogeneous and suitable for the adhesion of lacquer and offers you the magnificence of the lacquer.



LUX MODEL SERİSİ

Zengin profil detayları ile birlikte zarif hatlara sahip bu modellerde kullanılan klasik-modern çizgiler, göz alıcı bir görünüm elde edilmesini sağlar. Serilerin en detaylı profil açıklıklarına sahip modelleri bu grupta yer almaktadır.

LUX MODEL SERIES

In these models have stylish lines together with luxury profile details, provide an eye-catching look with classic-modern lines. This group includes the models with the most detailed profile gaps of the series.

POLİMERİK / POLYMERIC

Aden polimerik kaplama ürünleri, farklı renk ve desenlerden oluşan toplamda altı ayrı seçenekte sunulur. Lamine ahşap ve renk kaplama uygulamaları ile yüksek mukavemetli yoğunlukta üretilir. Bu özelliği sayesinde darbe ve çizilmelere karşı güçlü dayanıma sahiptir.

Aden polymeric veneer products presents six options with different colors and patterns. Polymeric models produced in high strength density with laminated wood veneer and color coating applications. Products has strong resistance against impacts and scratches because of this feature.

LAKE / LACQUERED

Aden lake boyalı ürünleri, iki farklı renk seçeneği ile sunulur. Mat ve ipeksi yüzeyi ile zarif bir görünüme sahiptir. Ahşap üzerine uygulanan astar katları, homojen ve boyanın tutunmasına uygun, pürüzsüz bir yüzey elde edilmesini sağlar ve sizlere lakenin ihtişamını sunar.

Aden lacquer products presents two different colors options. With matt and flossy surface products have elegant appearance. Lining coats applied on wood provide a smooth surface that is homogeneous and suitable for the adhesion of lacquer and offers you the magnificence of the lacquer.

36-39



ÖLÇÜ VE DETAY

Kapınızın ölçü seçeneklerine, kapı yön referans görsellerine ve standart olarak sunulan kapı donanım görsellerine buradan ulaşabilirsiniz.

Ayrıca sade, ulaşılabilir ve ergonomik olan Aden kol seti detaylarını inceleyebilirsiniz.

MEASUREMENT AND DETAIL

You can find the size options, opening direction, reference images and standard hardwares of doors details in here.

You can also view the details of the simple, accessible and ergonomic Aden handle set.

40-41



RENK PALETİ

Aden'e özel, polimerik yüzey kaplamalarına ve ipeksi mat lake boya uygulama renklerini inceleyebilirsiniz.

Toplamda 6 seçenekten oluşan bir skala sunuluyor.

COLOR PALETTE

You can view the polymeric surface veneer and silky matt lacquer paint application colors specific to Aden.

6 different colour options presents from scale.

MODEL ÖN İZLEMELERİ





005



C108-G

V E R I T A S
M O D E L
S E R I E
B A S I C
M I N I M A L

L U X
M O D E L
S E R I E
M A J O R
E L E G A N C E



138



707



098



C098-G



018



C018-G

7F2



C108-G5



5F1



5F2



PONTI
SERRI

420



410



MODELS IN
WHITE

CONTAINS
LACQUER
POLYMERIC
FINISHES

MODERN
DESIGNS
WITH GAPS

703



704



710



711



C108-G



VERITAS

A D

005



EN

IN

VERITAS

VERITAS

005

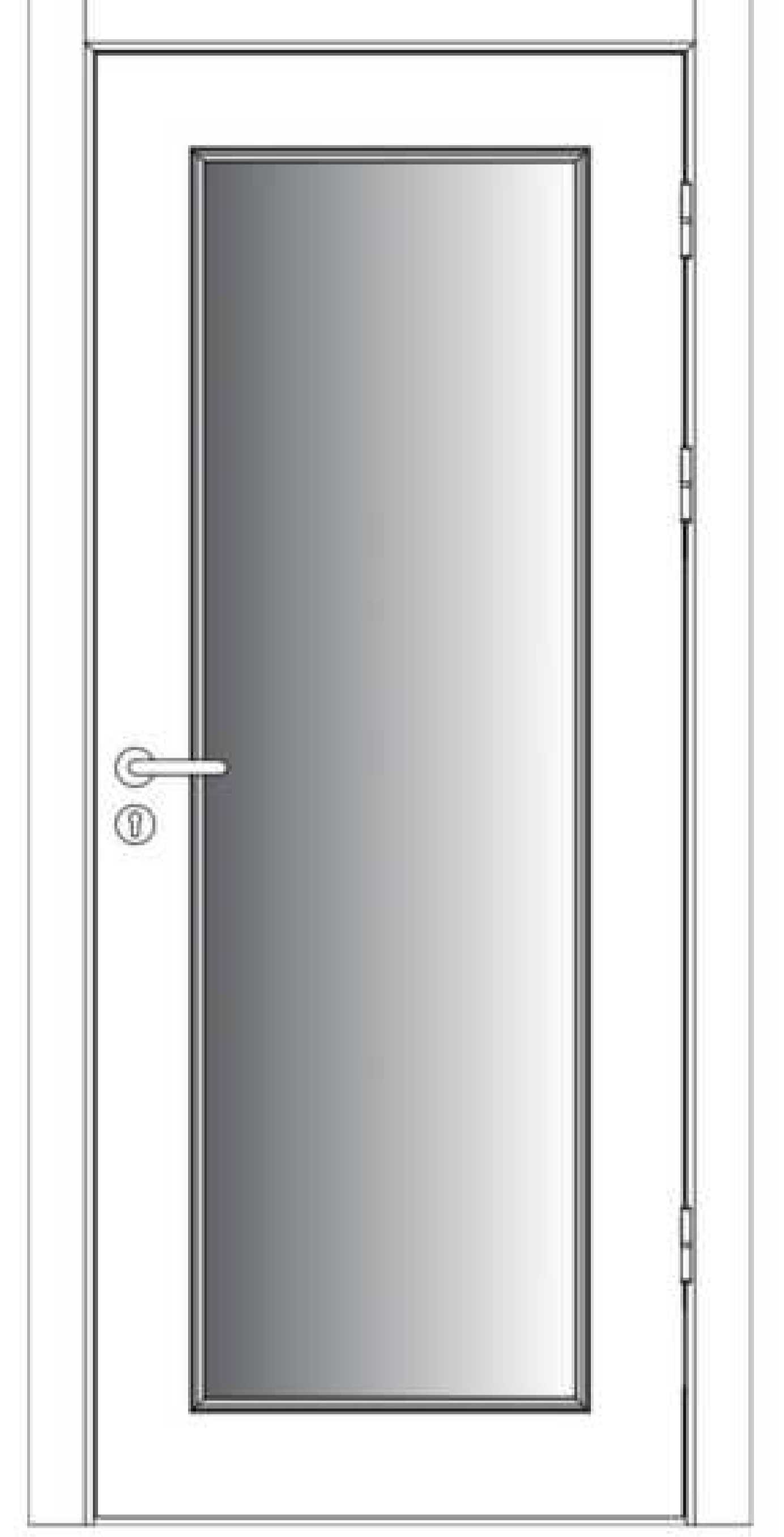
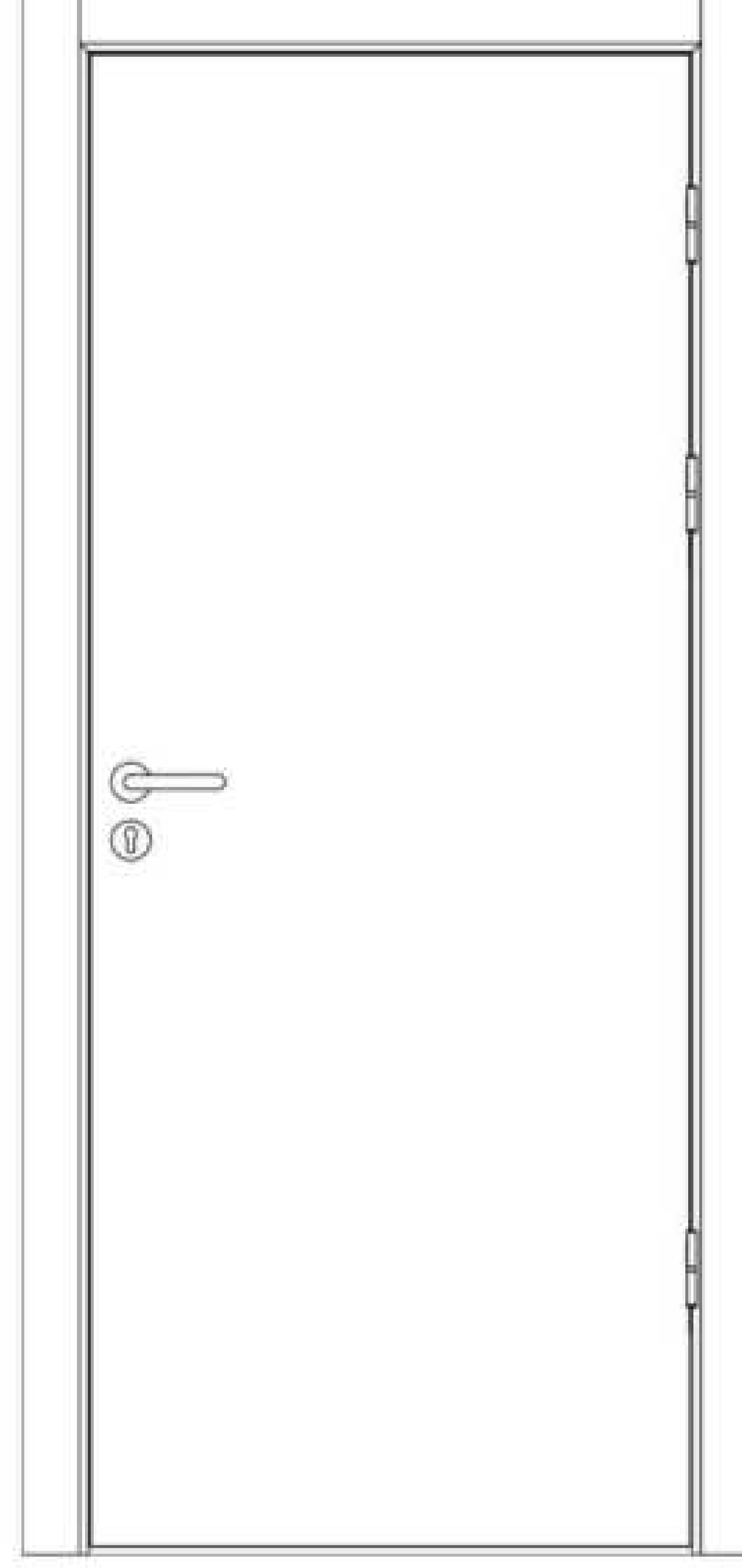

0 0 5

C108-G



AÇIK MEŞE / LIGHT OAK
POLİMERİK / POLYMERIC



CINAR / PLANE
POLİMERİK / POLYMERIC



TİK / TEAK
POLİMERİK / POLYMERIC

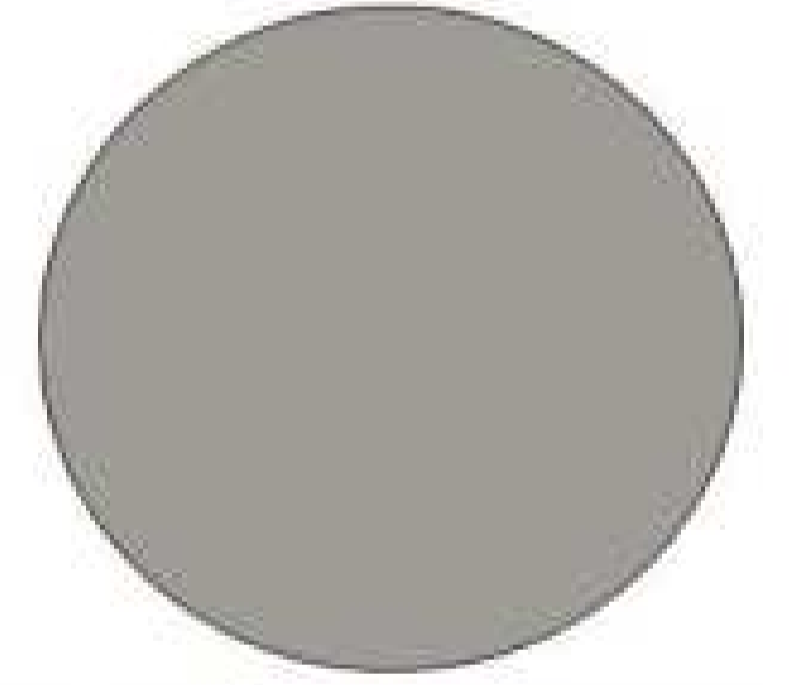

TAŞ GRİ / STONE GREY
POLİMERİK / POLYMERIC

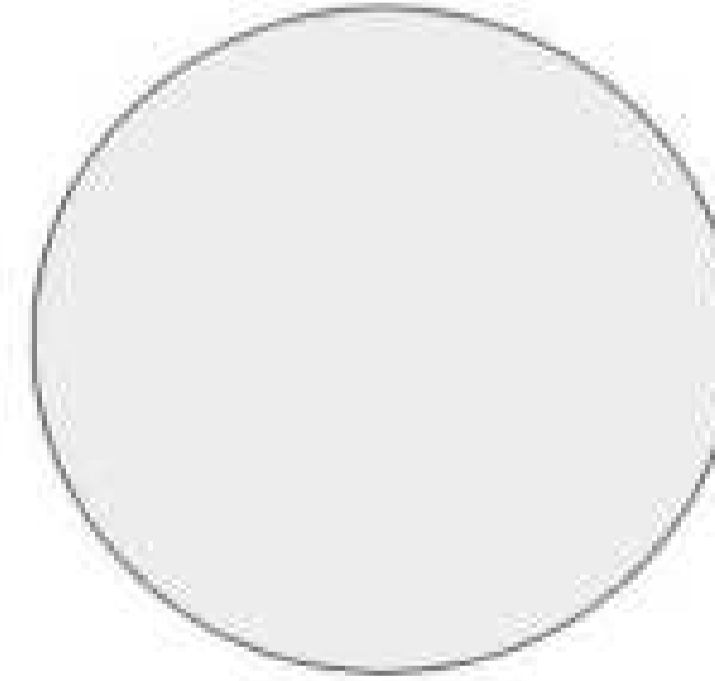

SOFT BEYAZ / SOFT WHITE
POLİMERİK / POLYMERIC

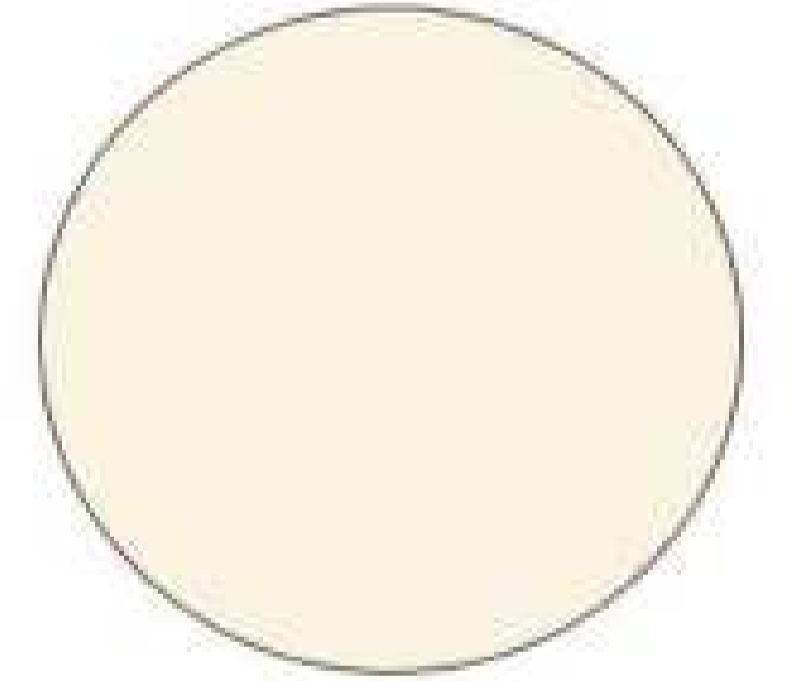

KREM / CREAM
POLİMERİK / POLYMERIC

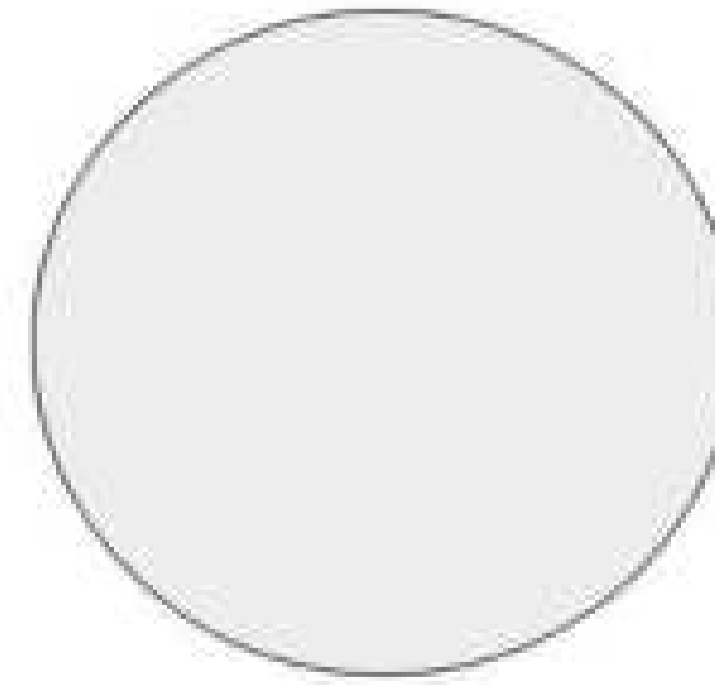

BEYAZ / WHITE
LAKE / LACQUER

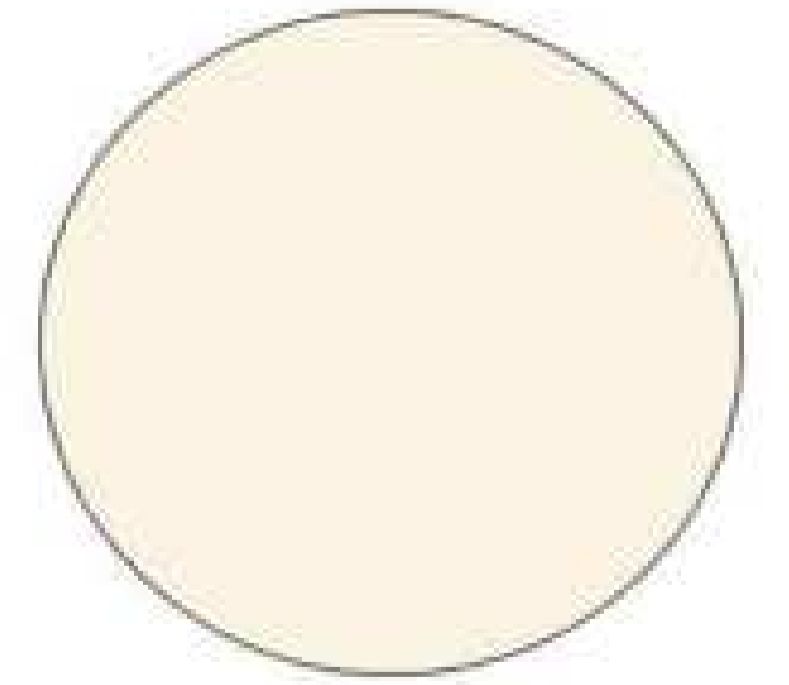

FİLDİŞİ / IVORY
LAKE / LACQUER

Düz ve camlı olmak üzere iki farklı modelden oluşan bu seride fuga veya profil detayı olmaksızın sade ve şık bir görünüm elde edilir. Veritas modelleri ile her zevke hitap edebilir veya farklı tasarımlara uyum sağlayabilirsiniz.

In this series, which includes two different models as flat and glazed doors, You can get a simple and stylish look without any joint or profile details. With Veritas models, you can pleasing to all tastes or you can adapt to different designs.

FRAME

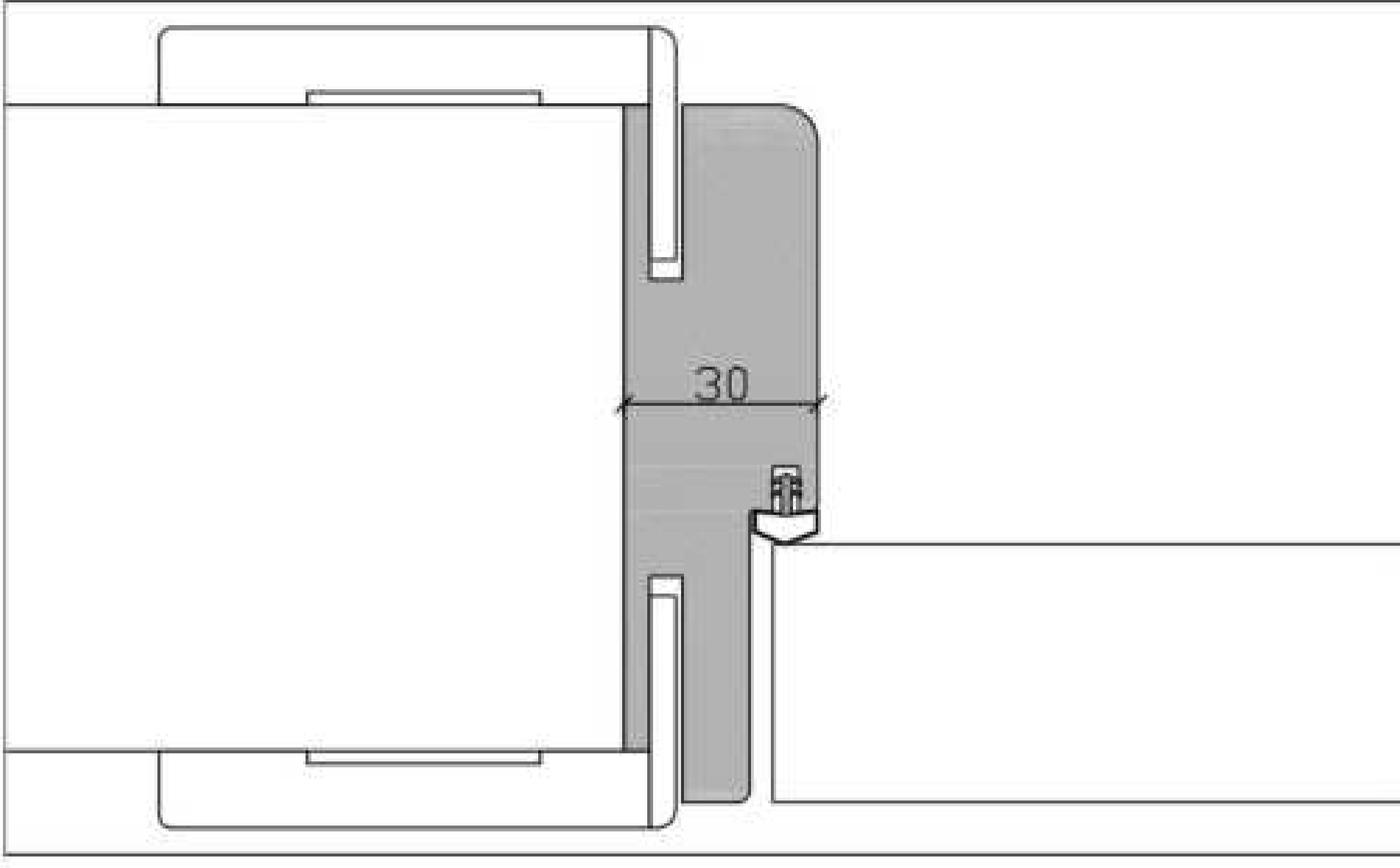

LEAF

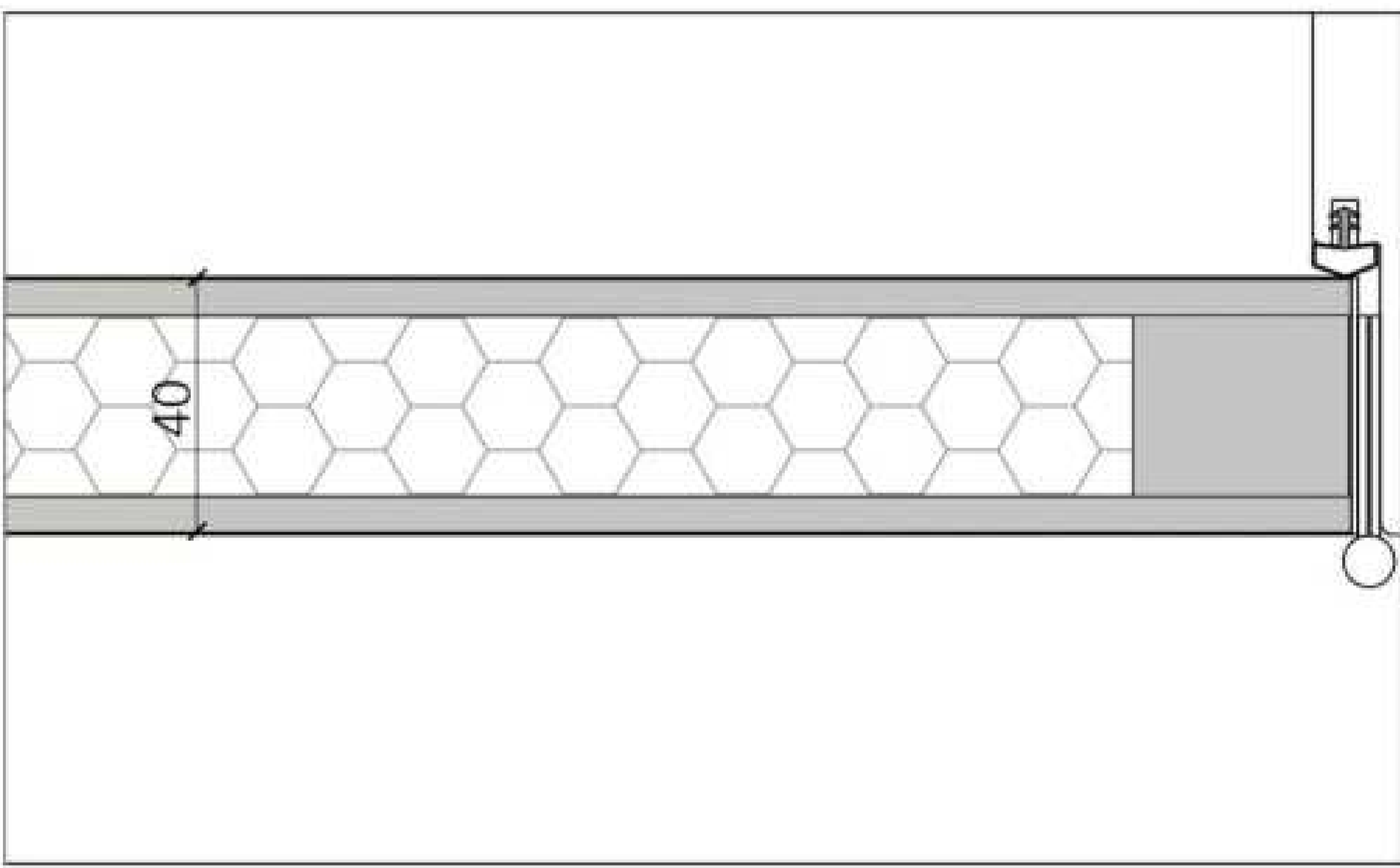

ARCHITRAVE

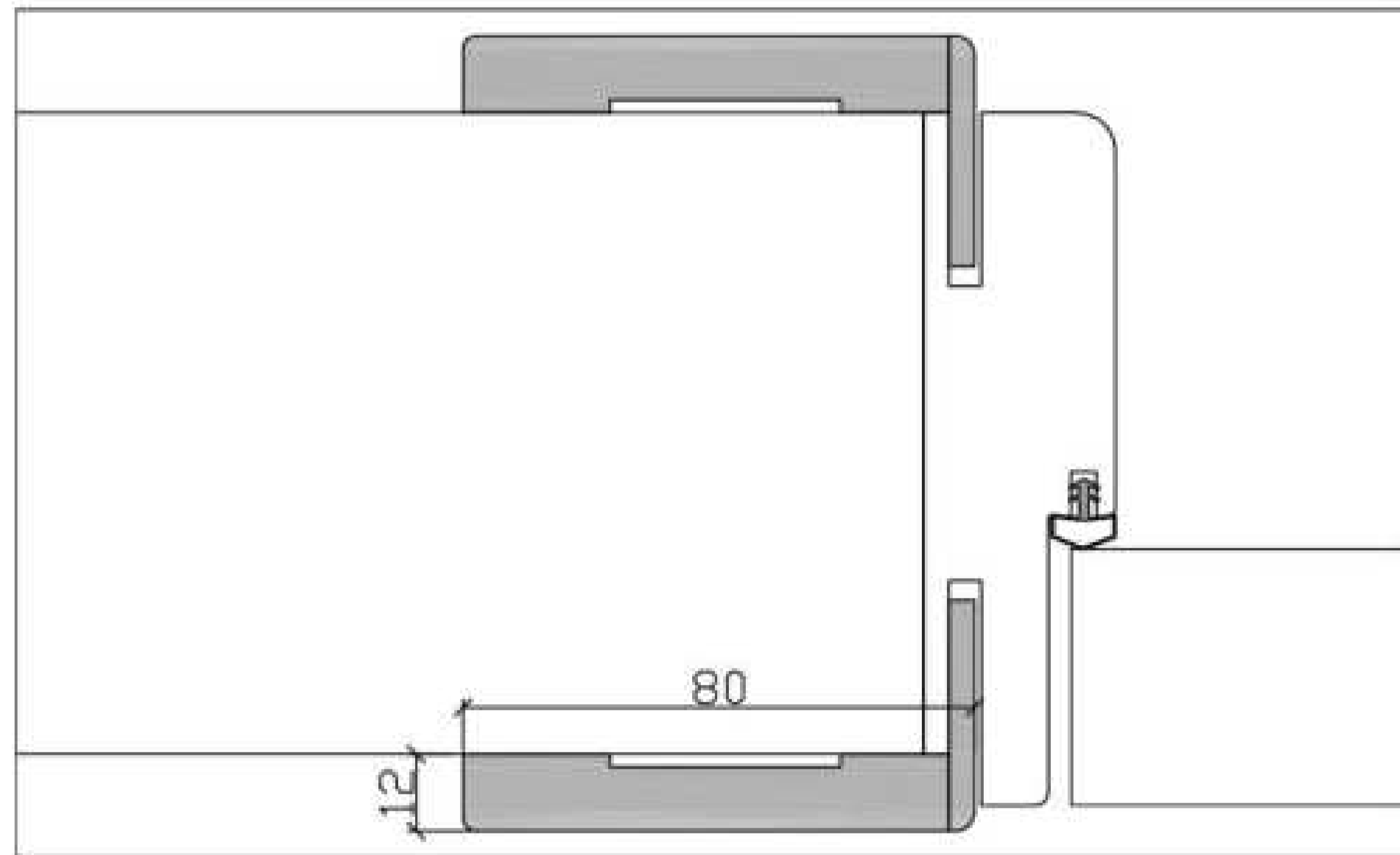

HARDWARE

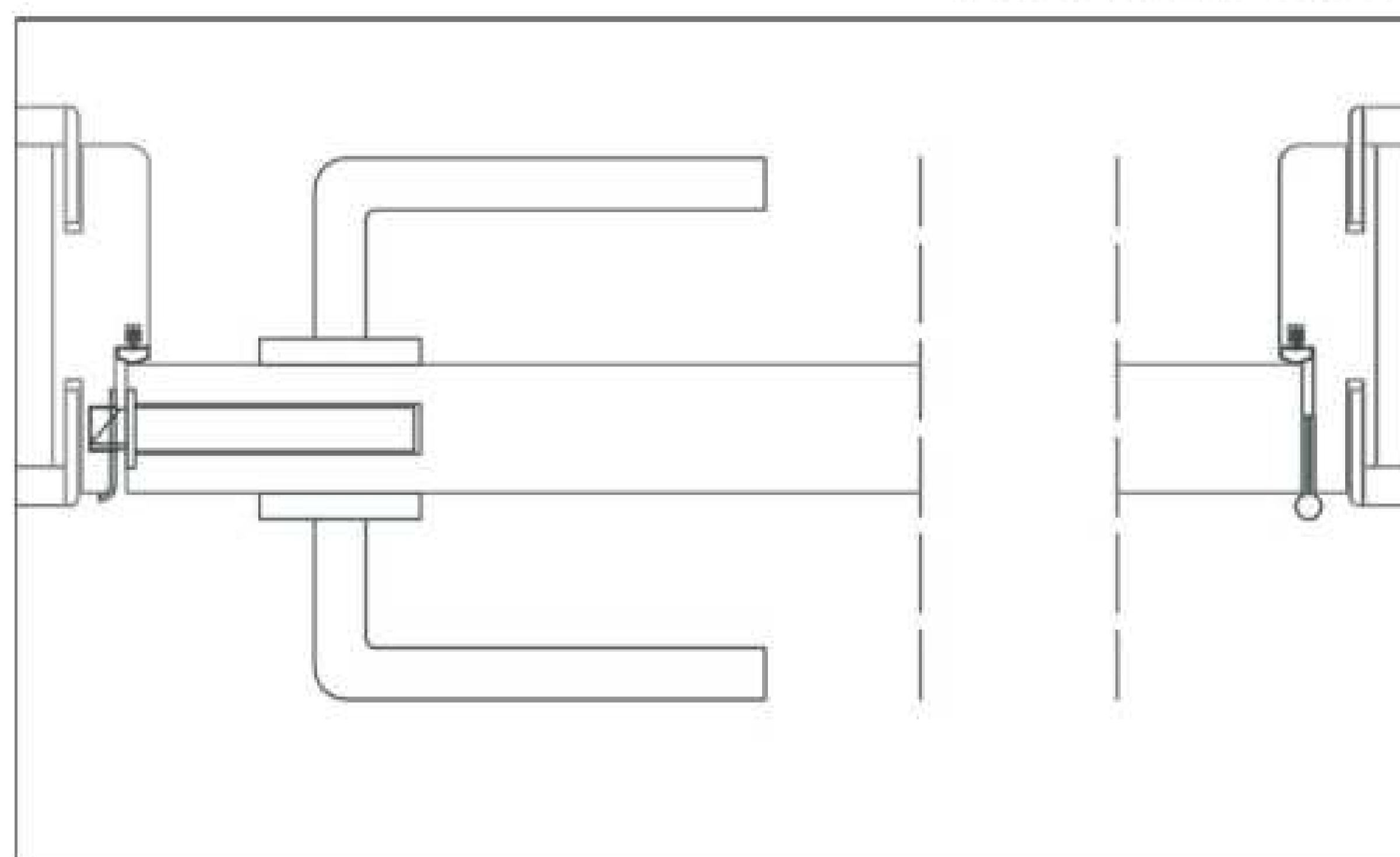

KASA

Aden serisi kapılarında, 30 mm MDF kasa standart olarak sunulur. Yüzeyler seçilen malzeme ve renkte tanımlanır. Kasa montaj öncesinde yerinde birleştirilir ve duvarla arasında kalan boşlukta 15 mm poliüretan dolgu malzemesi kullanılır. Duvar derinliğine göre farklı ölçü seçenekleri sunulmaktadır.

In Aden series doors, 30 mm MDF frame provided as standard. Surface defined with the selected material. Frame is assembled in the place before installation and the space between wall and frame fills with 15 mm polyurethane foam. Different size options are offered according to the depth of the wall.

KANAT

Tüm kapı modellerinde standart olarak 12mm kalınlığında 80 mm genişliğinde düz model mdf pervaz kullanılır. Pervaz yüzeyi kapı yüzeyi ile aynı malzeme/renk seçeneklerinden tercih edilir. Kapı üst başlık pervazı yan pervazlar arasında yerleştirilerek 90 derece köşe birleşim detayı sağlanmış olur.

Leafes are produced by fir wood door carcass with MDF surfaces on it and coated/painted with selected material. Total leaf thickness is 40 mm and side surfaces covered with edge band. Filler honeycomb is applied to the inner space.

PERVAZ

Tüm modellerde standart olarak 12 mm kalınlığında, 80 mm genişliğinde MDF pervaz çerçeveleri kullanılır. Yüzeyler seçilen malzemede tanımlanır. Pervazlar, kasa içerisine geçirilerek sabitlenir. Köşe pervaz 90° detayında birleştirilir. Yatay pervaz, dikey pervazların arasında konumlanır.

Architraves are standard in all models with 12 mm thickness and 80 mm MDF. Surfaces defined with the selected material. Arches slides inside of the frame and fixed. Upper corners joins together on 90° detail. Horizontal architrave is placed between vertical architraves.

AKSESUAR

Kapı temel elemanlarına ek olarak üçlü menteşe seti, kilit seti, kilit karşılığı ve model ile uyumlu fitil kapı seti ile birlikte gelir. Kol seti yuvası ise seçilen ilgili aralıktaki modele göre açılır ve ayrıca uygulanır. Opsiyonel olarak standart Aden kol setini de ürününüze ekleyebilirsiniz.

In addition to the basic elements of door, triple hinge set, lock counterpart and seal (compatible with door), comes with the product. Handle set slots opens according to model and applied separately. Optionally, you can add standard Aden handle set to your product.

410



P O N T E

A D

711



PONTE

P O N T E

7F2

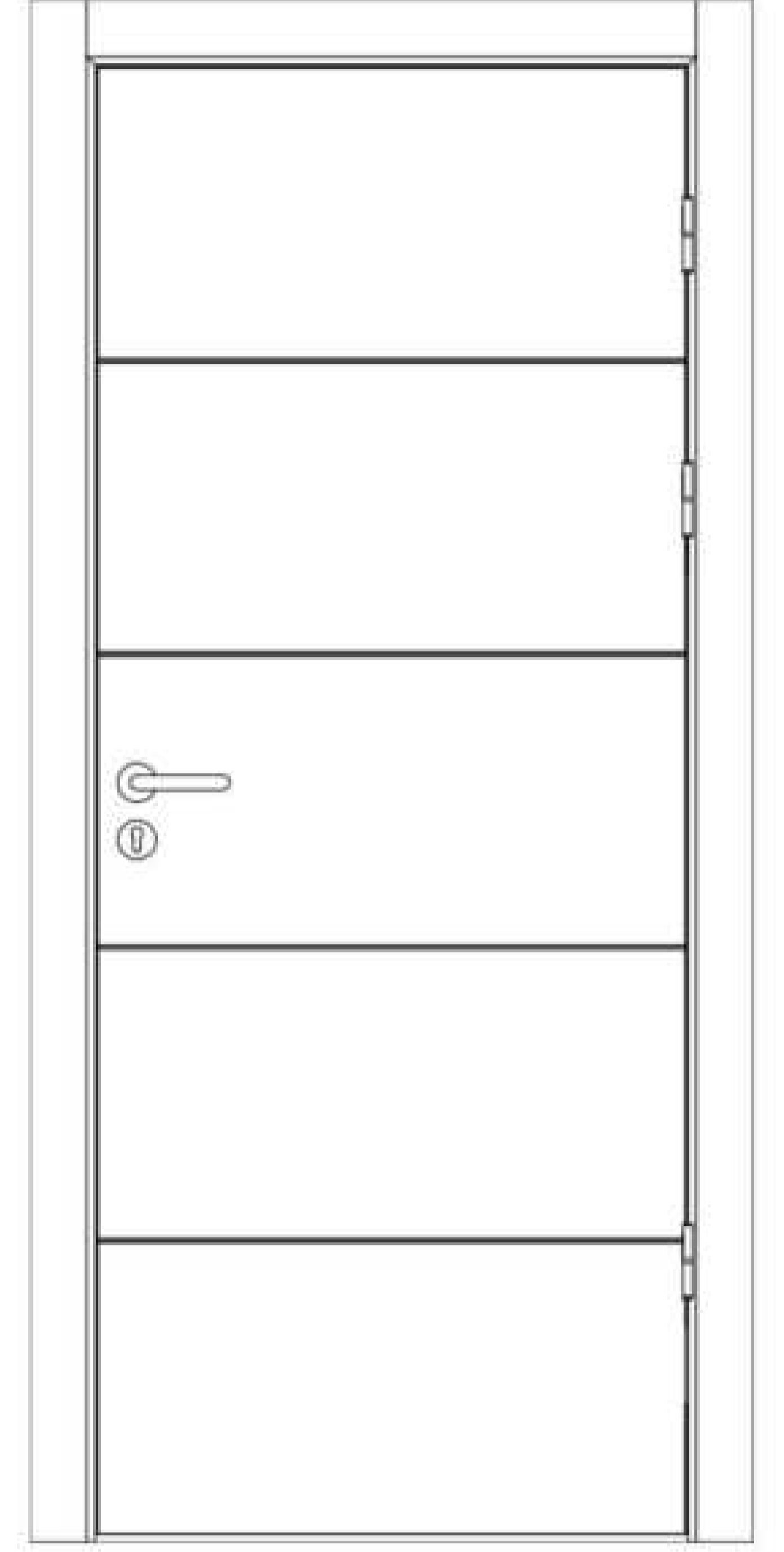
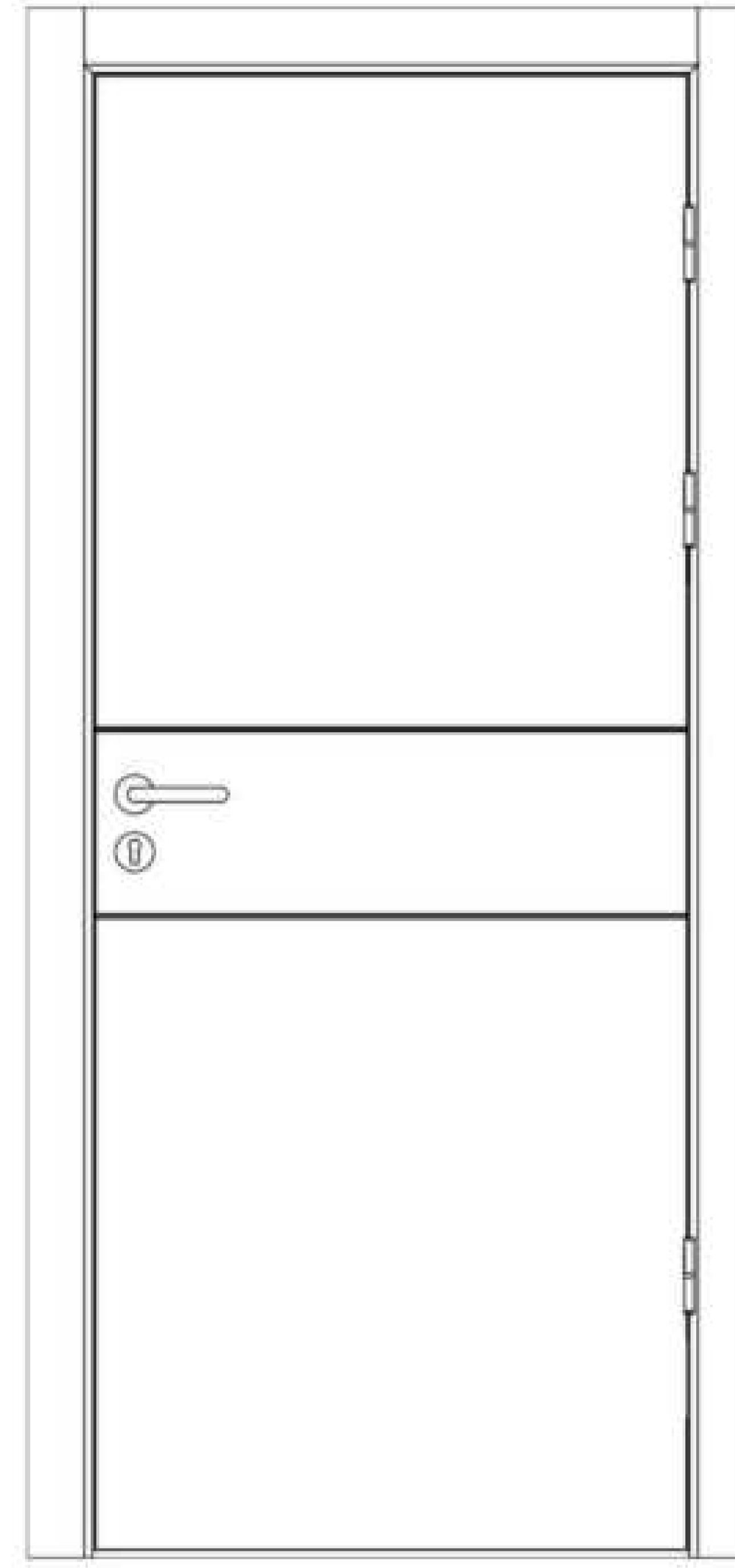

5 F 1

5 F 2



AÇIK MEŞE / LIGHT OAK
POLİMERİK / POLYMERIC



CINAR / PLANE
POLİMERİK / POLYMERIC



TİK / TEAK
POLİMERİK / POLYMERIC

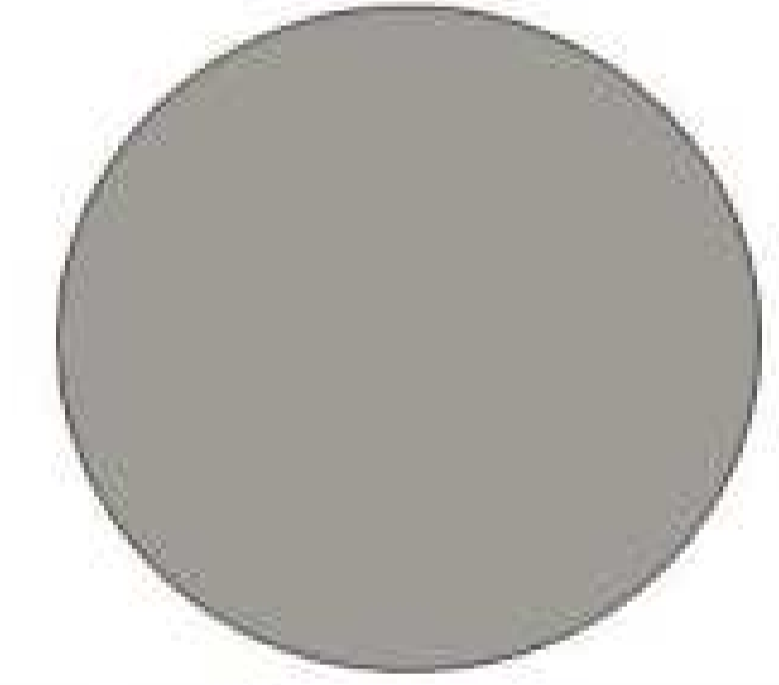

TAŞ GRİ / STONE GREY
POLİMERİK / POLYMERIC

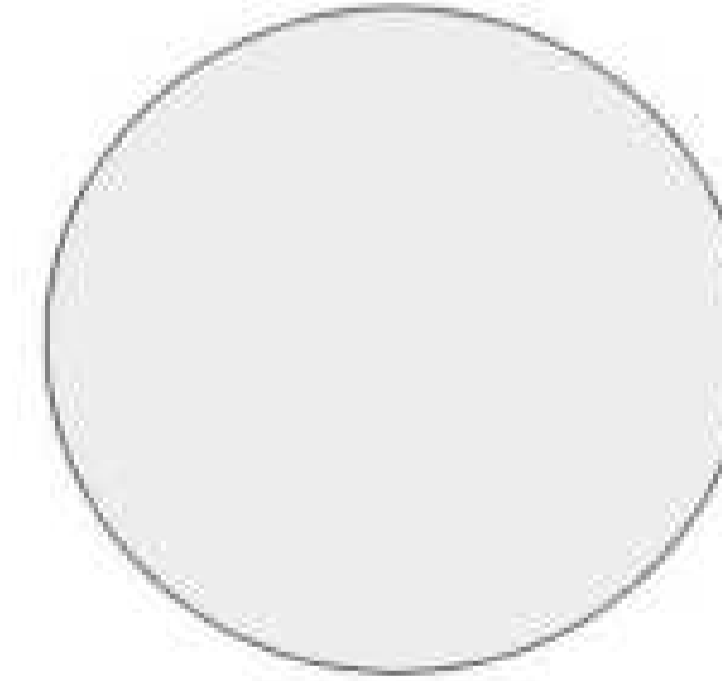

SOFT BEYAZ / SOFT WHITE
POLİMERİK / POLYMERIC

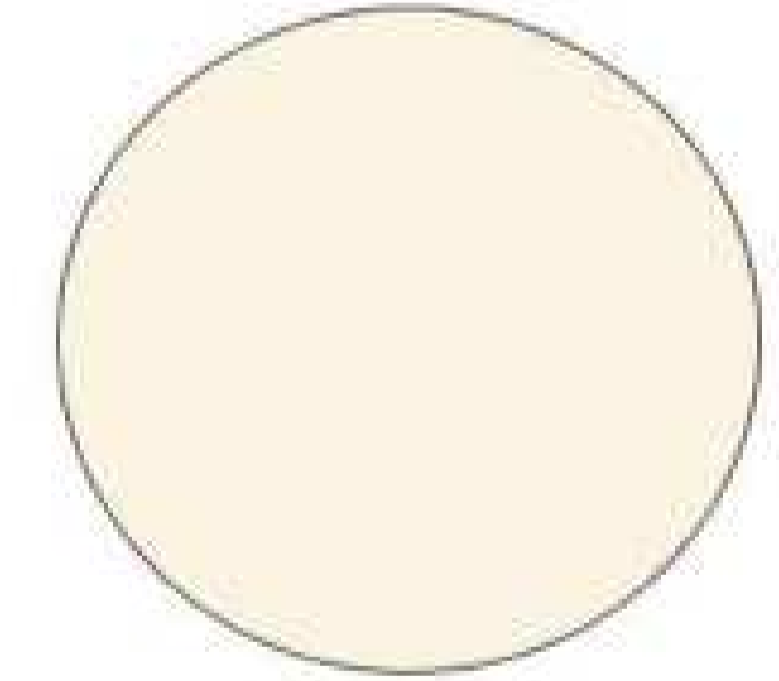

KREM / CREAM
POLİMERİK / POLYMERIC

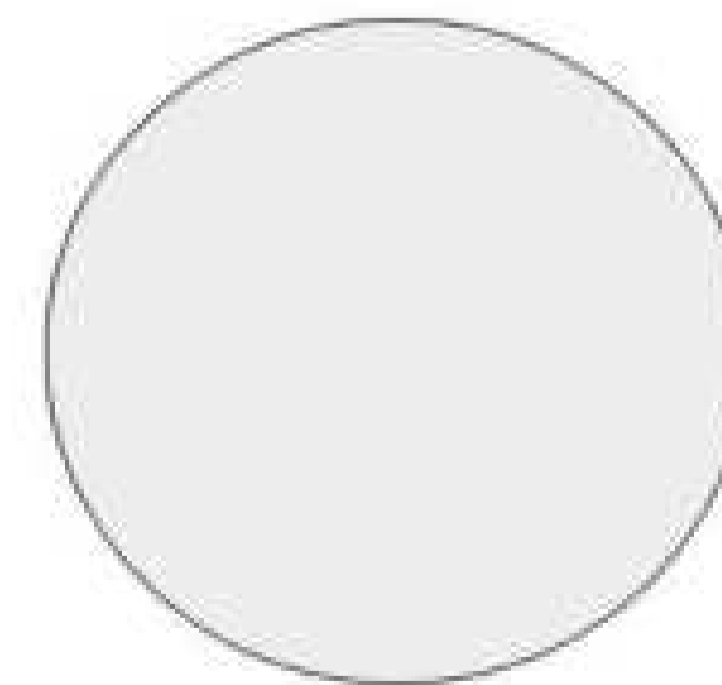

BEYAZ / WHITE
LAKE / LACQUER

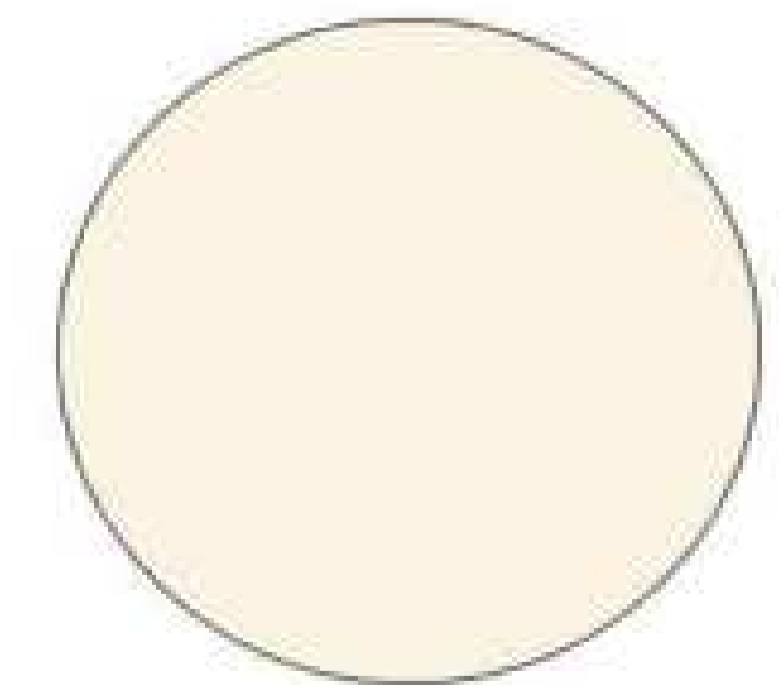

FİLDİŞİ / IVORY
LAKE / LACQUER

Farklı desen ve şekillerde yaratıcı modern tasarımlara yer verilen bu seride, 10 farklı model sunulmakta. Minimal detaylar ile oluşturulan seçeneklerden konsept ve tarzınıza uygun bir tercih yapabilirsiniz.

In this series, which includes creative modern designs in different patterns and shapes with presented 10 different models. You can make a choice that suits your concept and style from created options with minimal details.

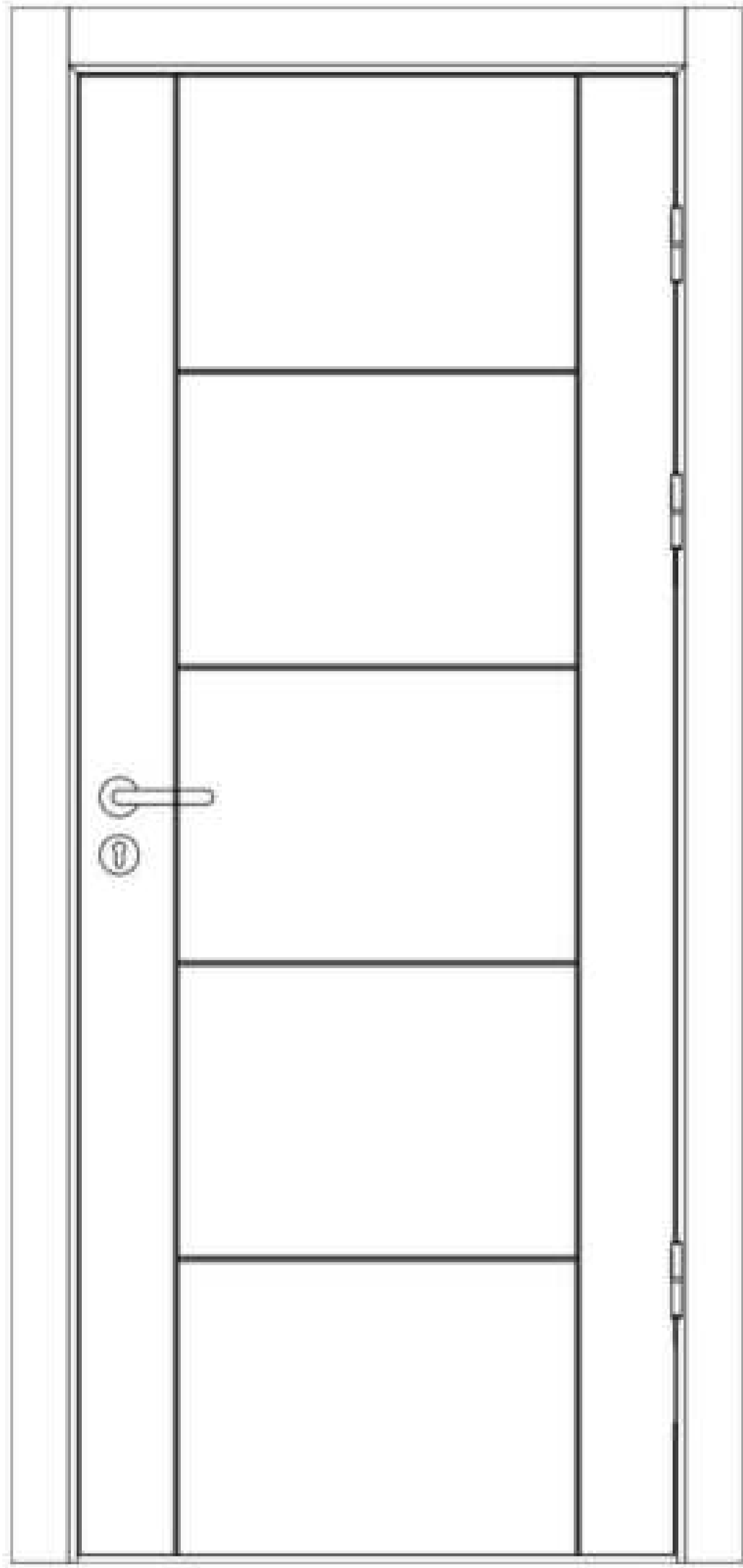

7 F 2

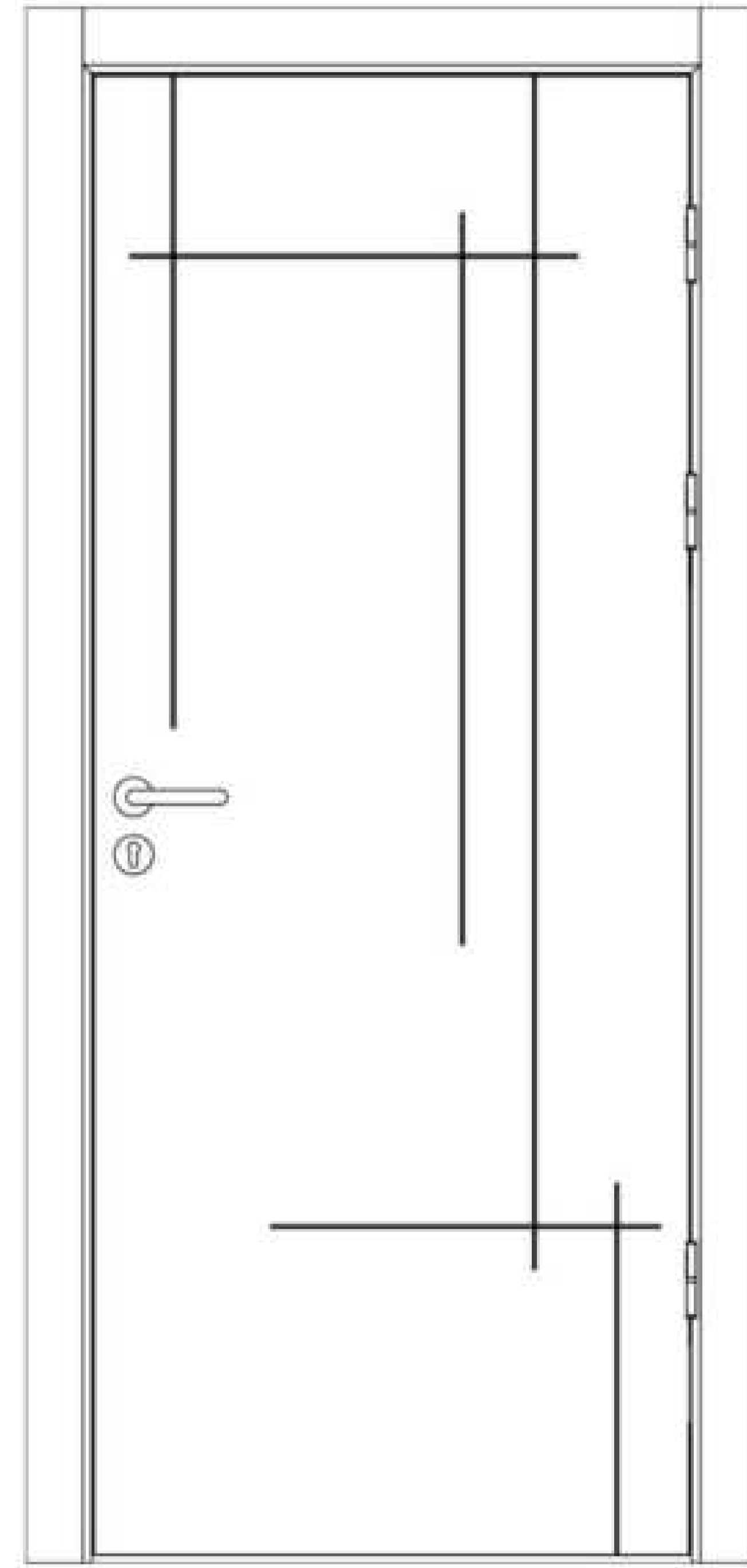

7 0 3

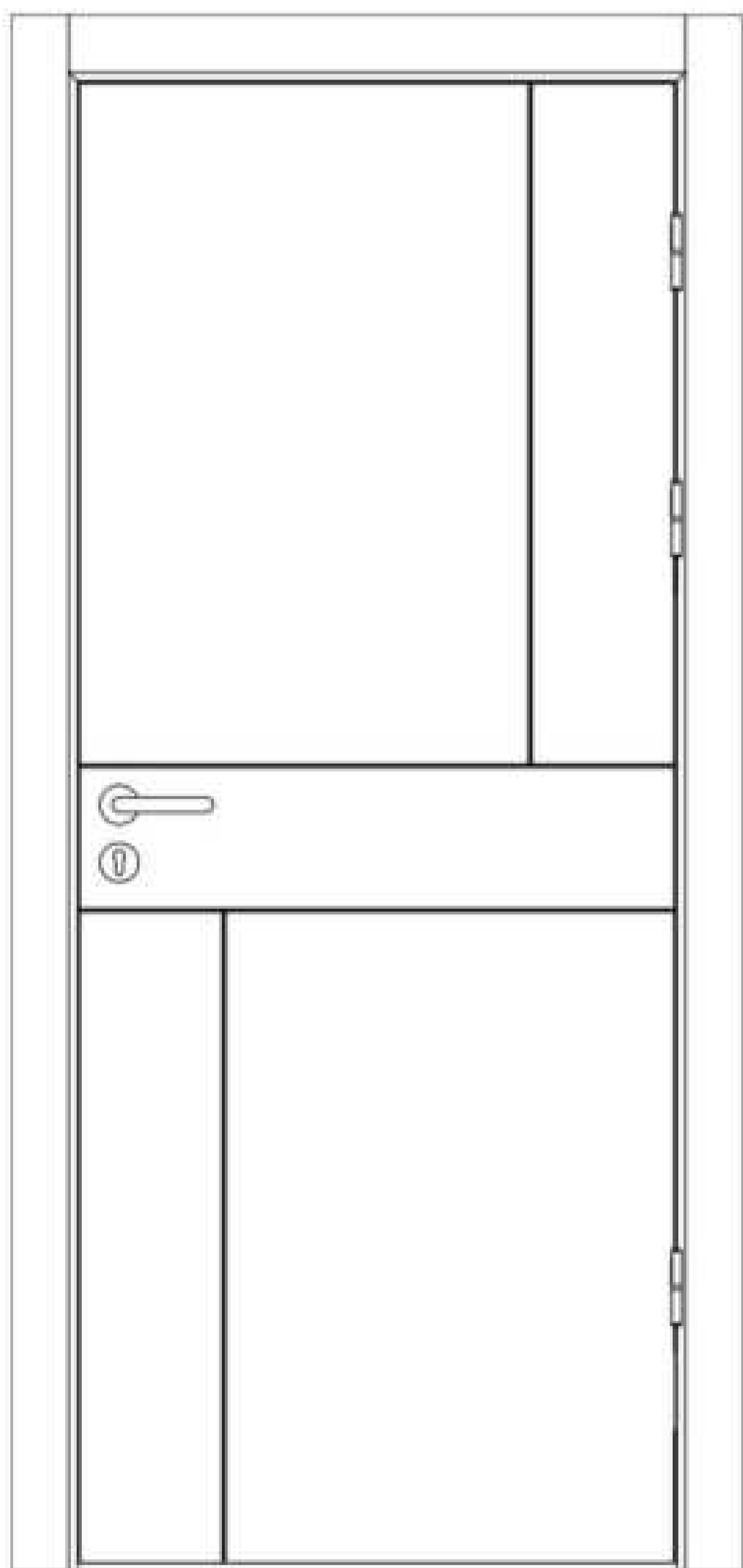

7 0 4

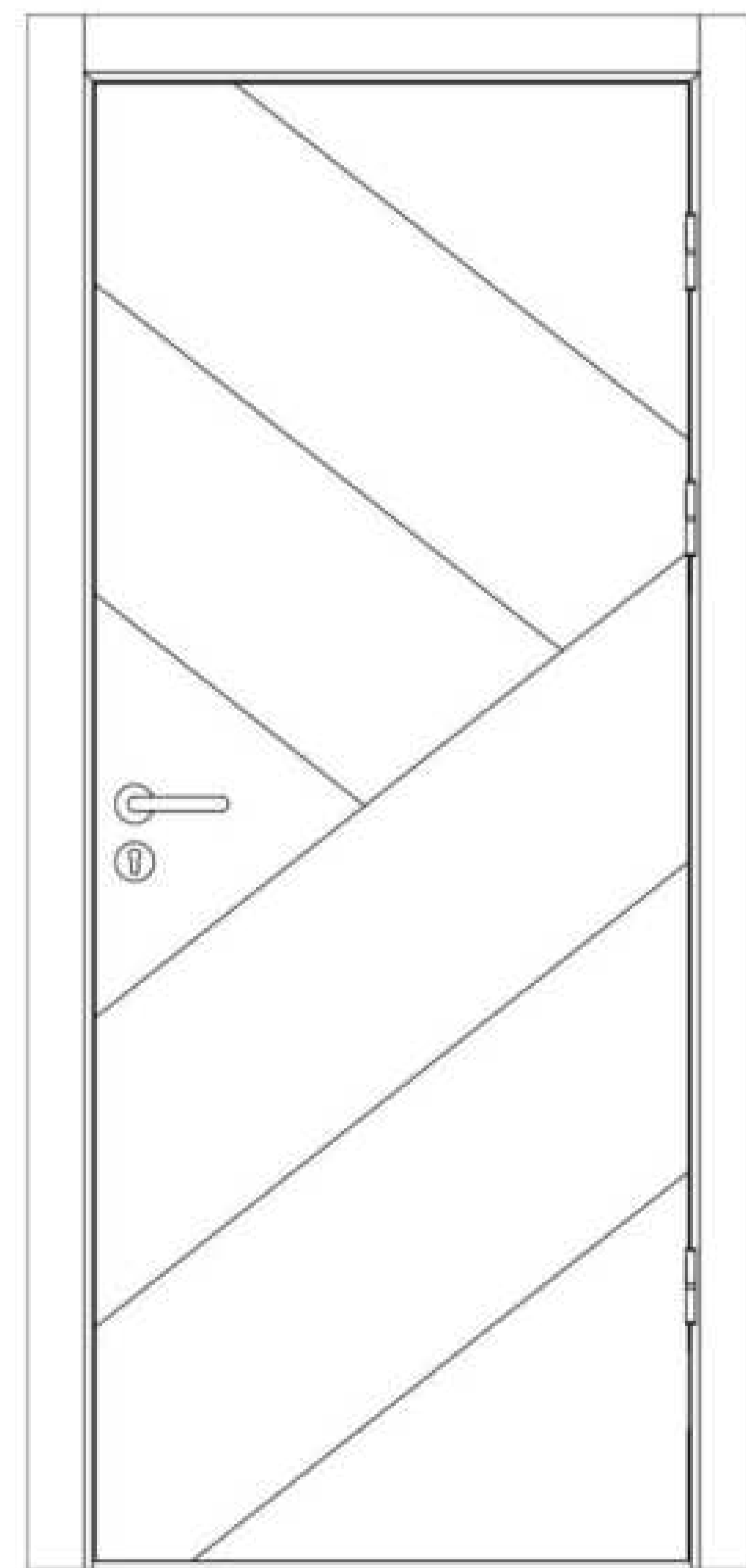

7 1 0

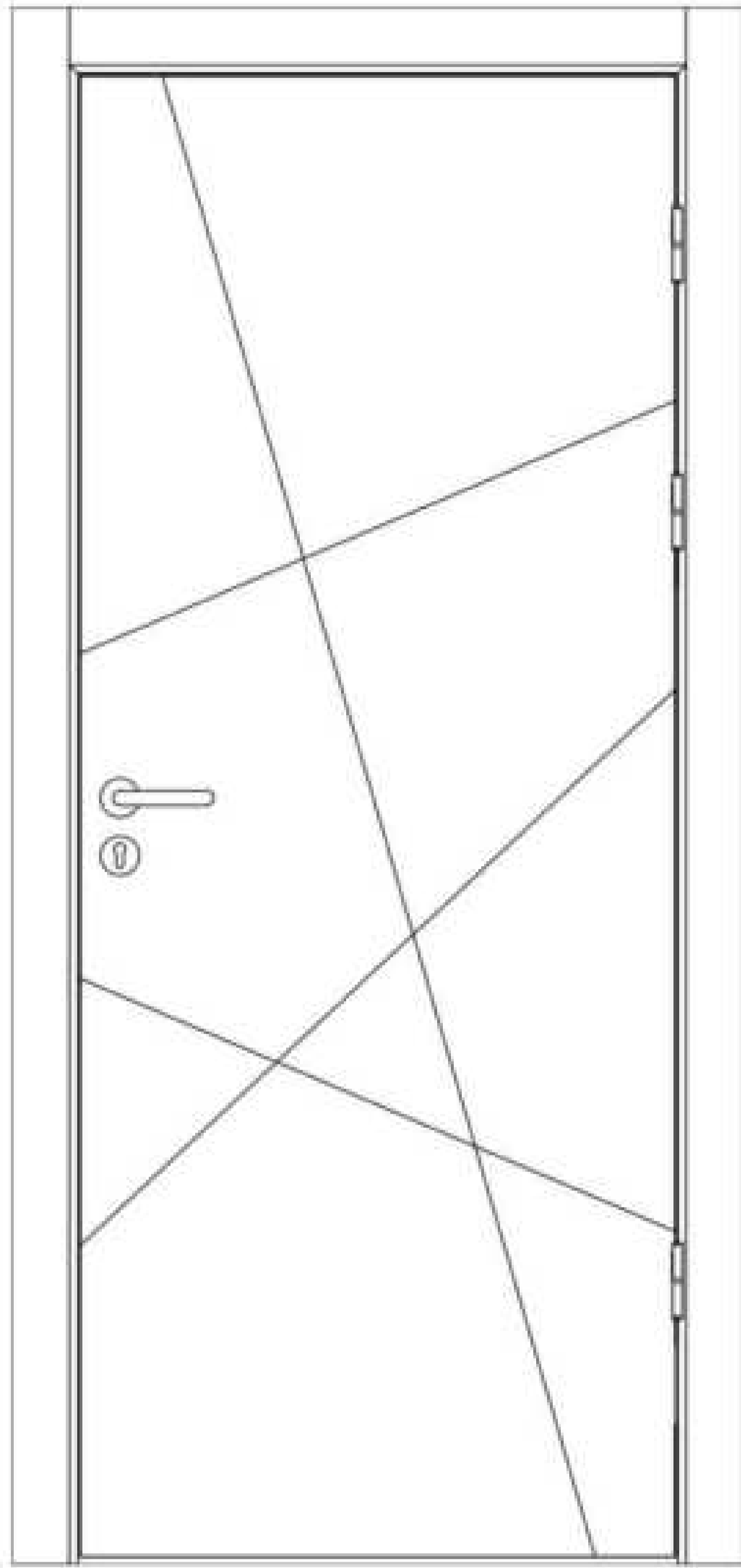

7 1 1

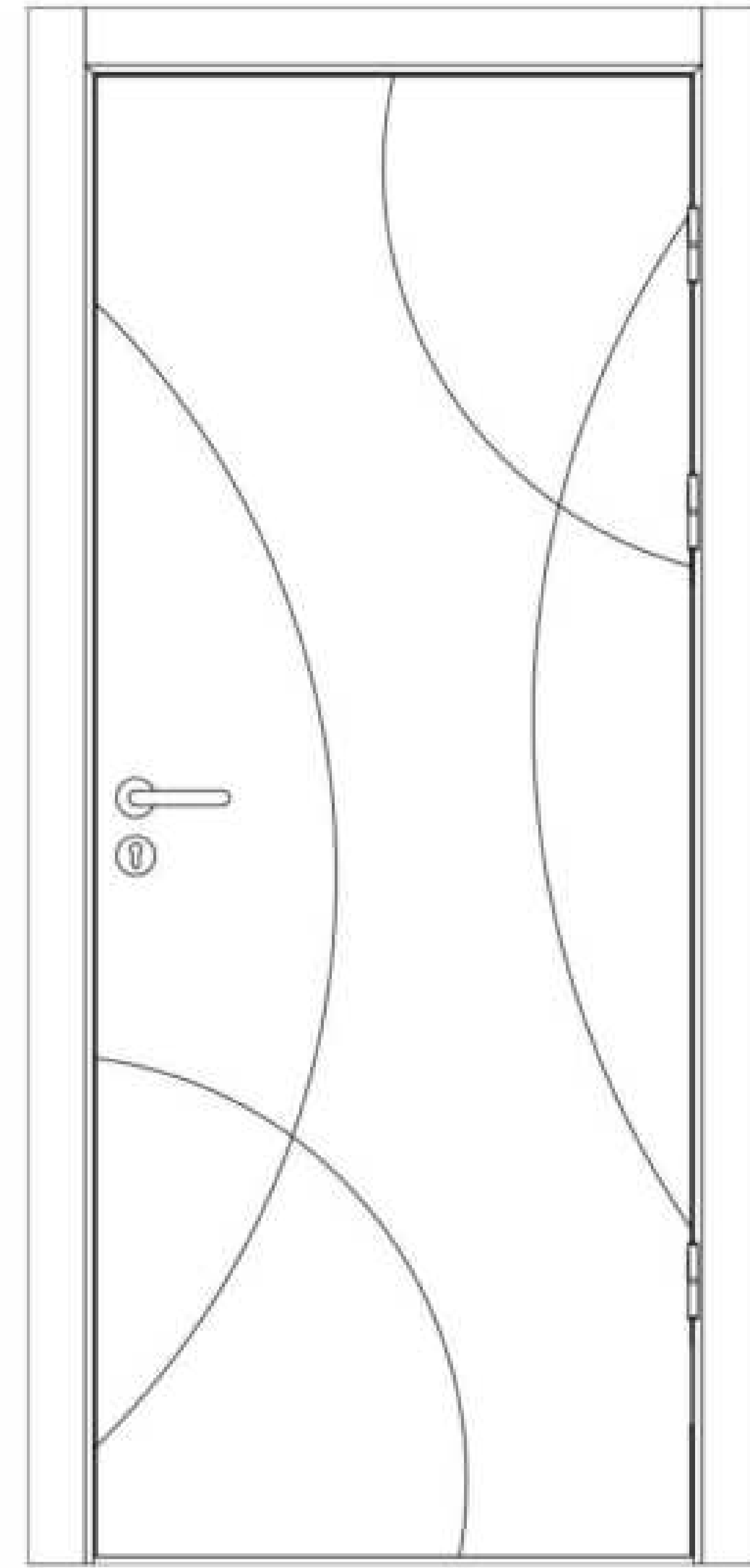

4 1 0

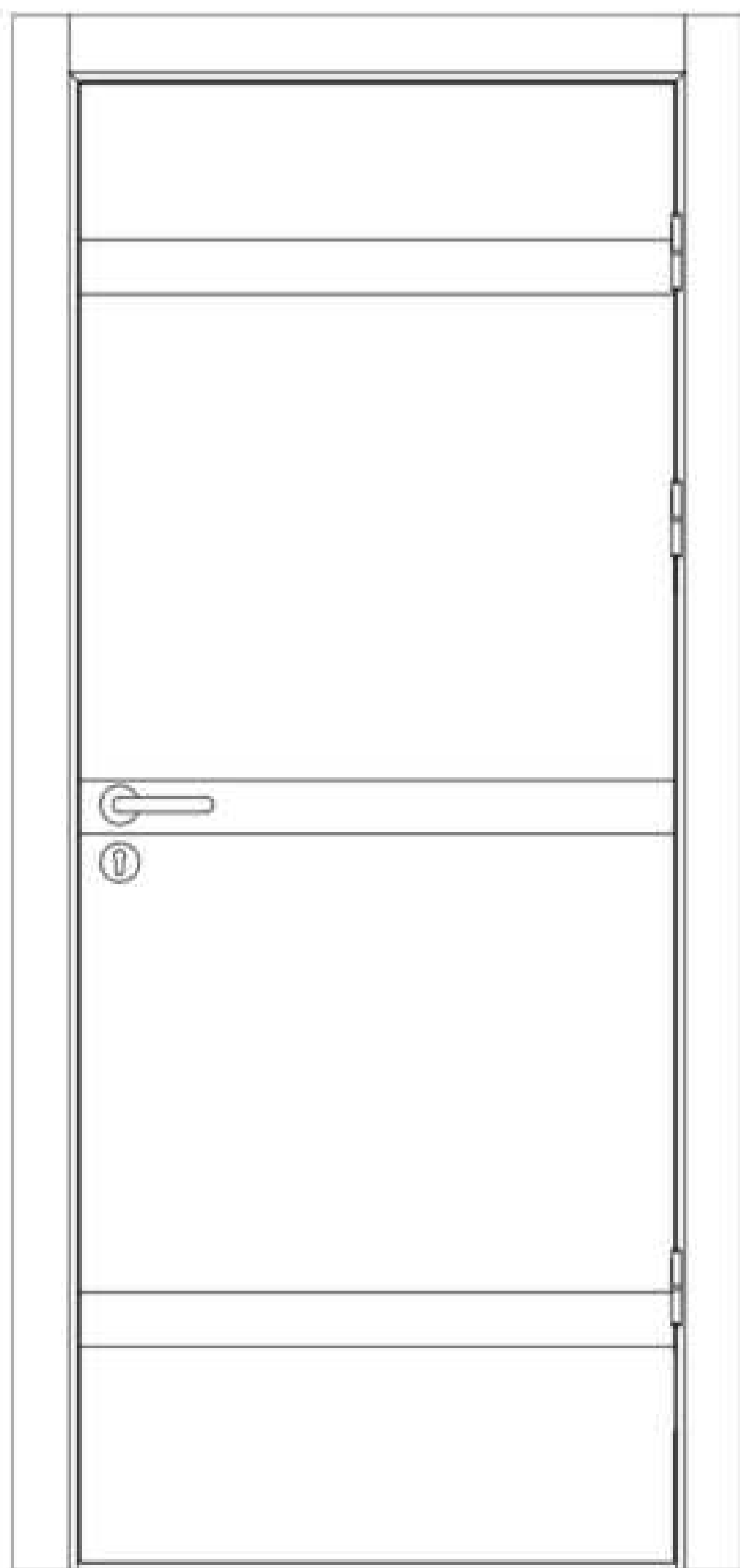

4 2 0

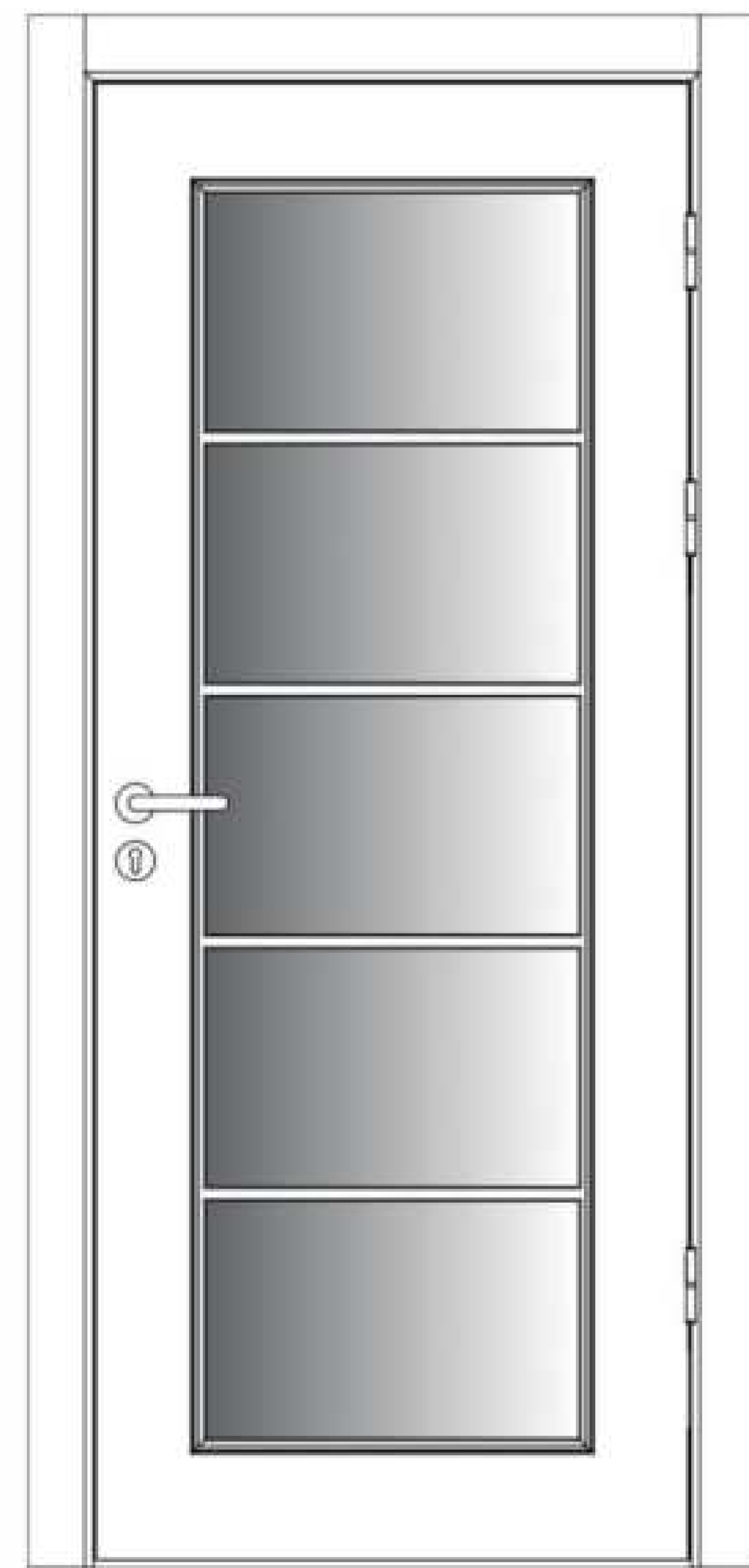

C108-G5

FRAME

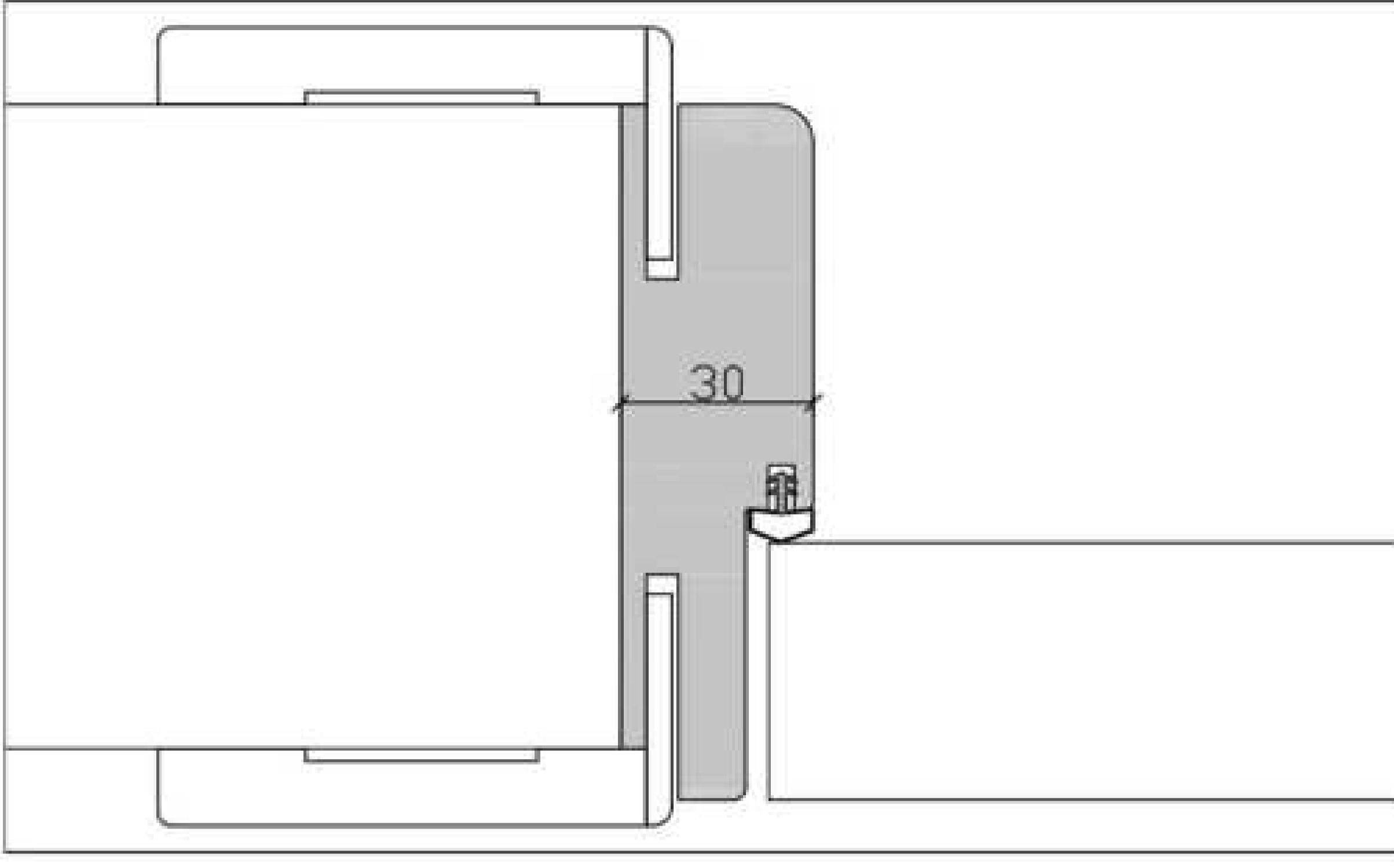

LEAF

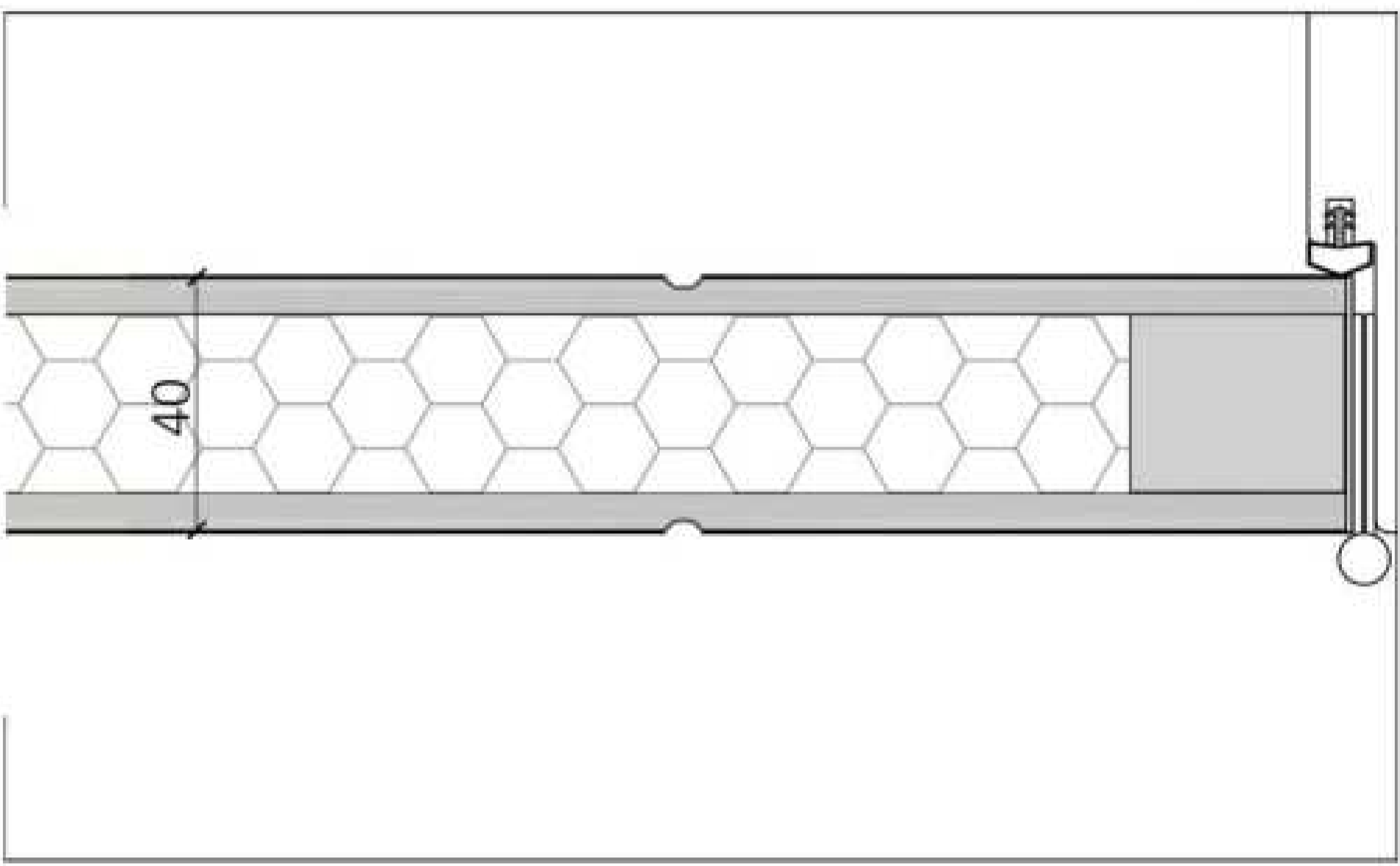

ARCHITRAVE

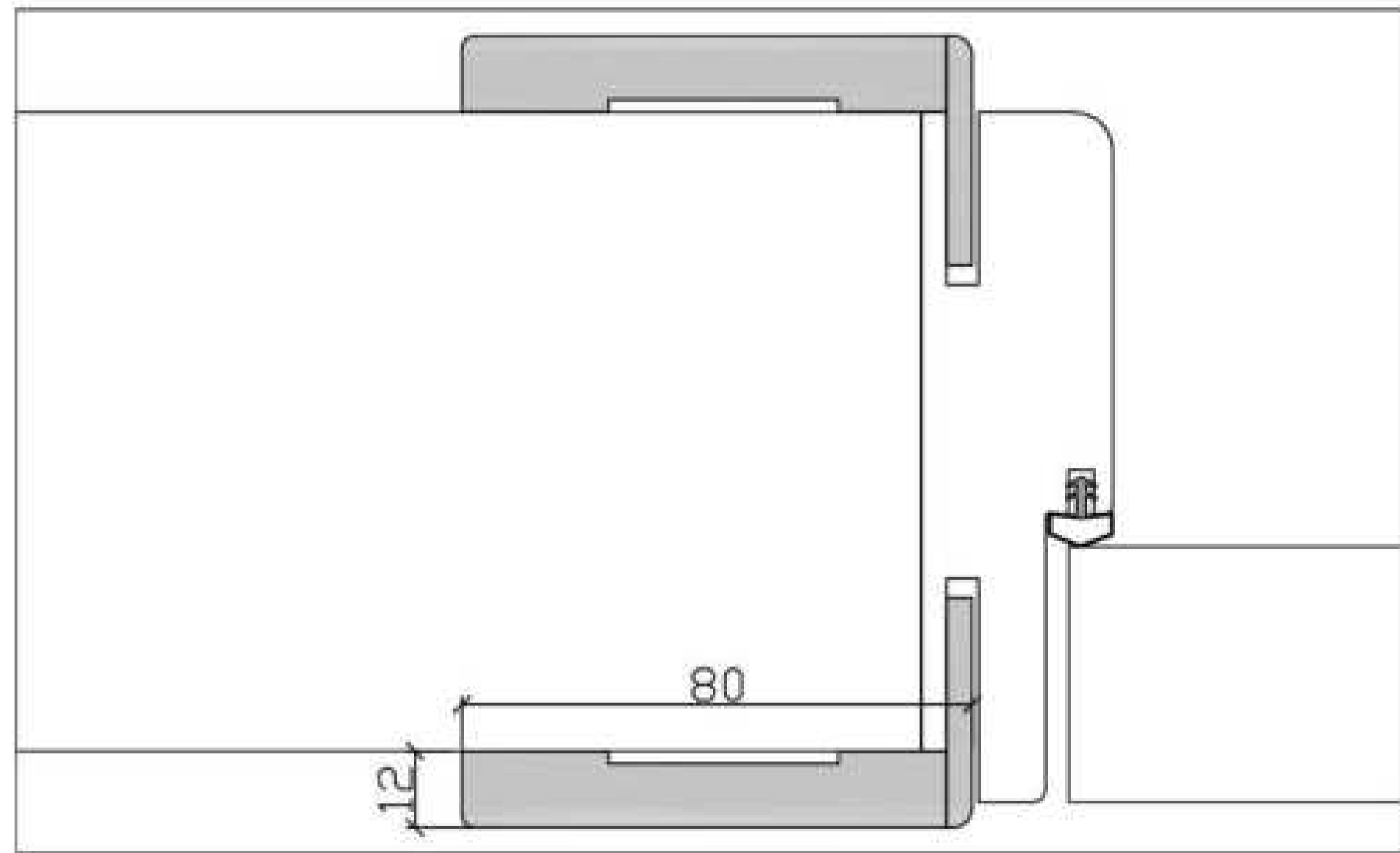

HARDWARE

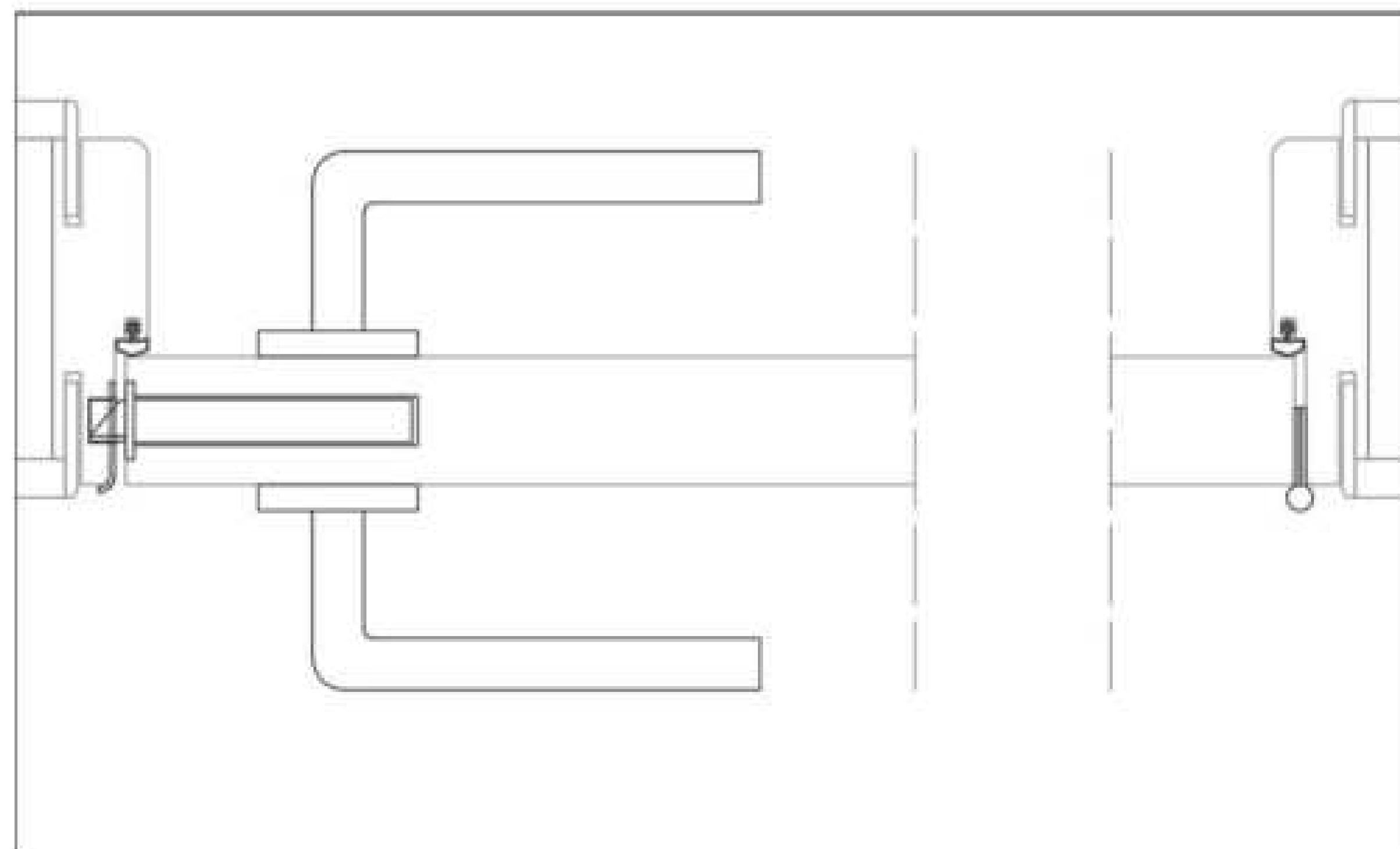

KASA

Aden serisi kapılarında, 30 mm MDF kasa standart olarak sunulur. Yüzeyler seçilen malzeme ve renkte tanımlanır. Kasa montaj öncesinde yerinde birleştirilir ve duvarla arasında kalan boşlukta 15 mm poliüretan dolgu malzemesi kullanılır. Duvar derinliğine göre farklı ölçü seçenekleri sunulmaktadır.

In Aden series doors, 30 mm MDF frame provided as standard. Surface defined with the selected material. Frame is assembled in the place before installation and the space between wall and frame fills with 15 mm polyurethane foam. Different size options are offered according to the depth of the wall.

KANAT

Tüm kapı modellerinde standart olarak 12mm kalınlığında 80 mm genişliğinde düz model mdf pervaz kullanılır. Pervaz yüzeyi kapı yüzeyi ile aynı malzeme/renk seçeneklerinden tercih edilir. Kapı üst başlık pervazı yan pervazlar arasında yerleştirilerek 90 derece köşe birleşim detayı sağlanmış olur.

Leafes are produced by fir wood door carcass with MDF surfaces on it and coated/painted with selected material. Total leaf thickness is 40 mm and side surfaces covered with edge band. Filler honeycomb is applied to the inner space.

PERVAZ

Tüm modellerde standart olarak 12 mm kalınlığında, 80 mm genişliğinde MDF pervaz çerçeveleri kullanılır. Yüzeyler seçilen malzemede tanımlanır. Pervazlar, kasa içerisine geçirilerek sabitlenir. Köşe pervaz 90° detayında birleştirilir. Yatay pervaz, dikey pervazların arasında konumlanır.

Architraves are standard in all models with 12 mm thickness and 80 mm MDF. Surfaces defined with the selected material. Arches slides inside of the frame and fixed. Upper corners joins together on 90° detail. Horizontal architrave is placed between vertical architraves.

AKSESUAR

Kapı temel elemanlarına ek olarak üçlü menteşe seti, kilit seti, kilit karşılığı ve model ile uyumlu fitil kapı seti ile birlikte gelir. Kol seti yuvası ise seçilen ilgili aralıktaki modele göre açılır ve ayrıca uygulanır. Opsiyonel olarak standart Aden kol setini de ürününüze ekleyebilirsiniz.

In addition to the basic elements of door, triple hinge set, lock counterpart and seal (compatible with door), comes with the product. Handle set slots opens according to model and applied separately. Optionally, you can add standard Aden handle set to your product.

018



L U X

A D

098



E N L U X



Geniş açıklıklı profil detayları ile birlikte zarif hatlara sahip bu modellerde kullanılan detaylar, klasik-modern tarzda göz alıcı bir görünüm elde edilmesini sağlar. Serilerin en detaylı profil açıklıklarına sahip modellerini barındırır.

In these models have stylish lines together with luxury profile details, provide an eye-catching look with classic-modern lines. This group includes the models with the most detailed profile gaps of the series.

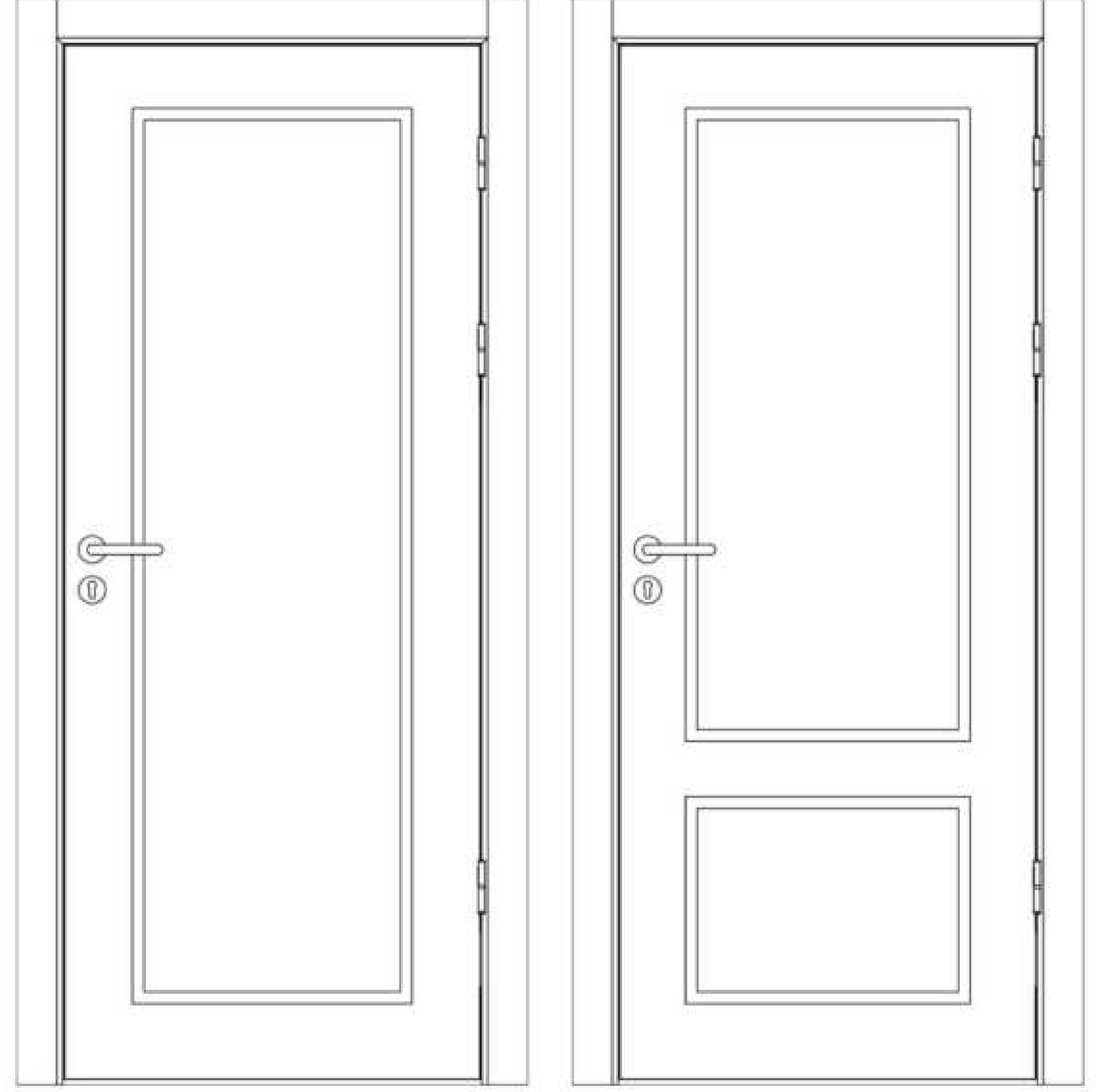

1 3 8

0 1 8



AÇIK MEŞE / LIGHT OAK
POLİMERİK / POLYMERIC



CINAR / PLANE
POLİMERİK / POLYMERIC



TİK / TEAK
POLİMERİK / POLYMERIC

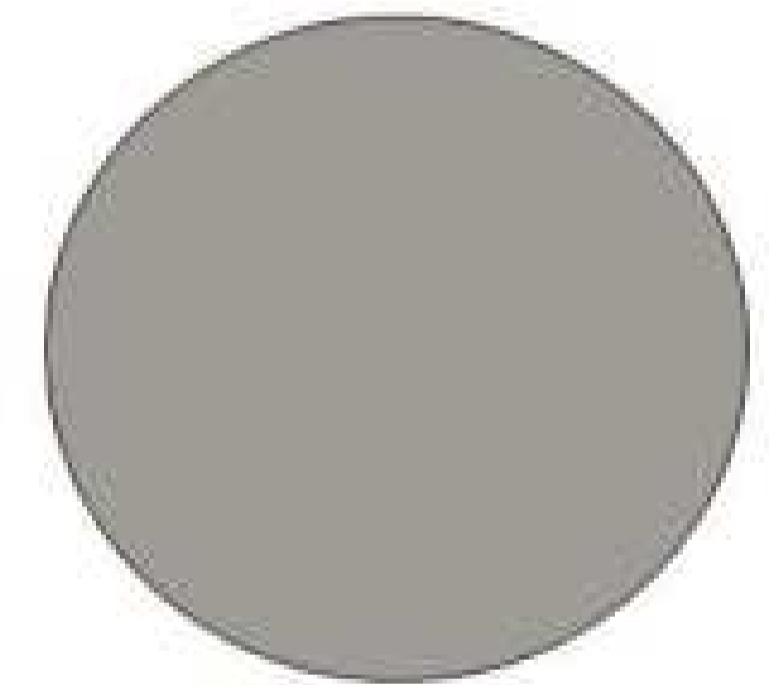

TAŞ GRİ / STONE GREY
POLİMERİK / POLYMERIC

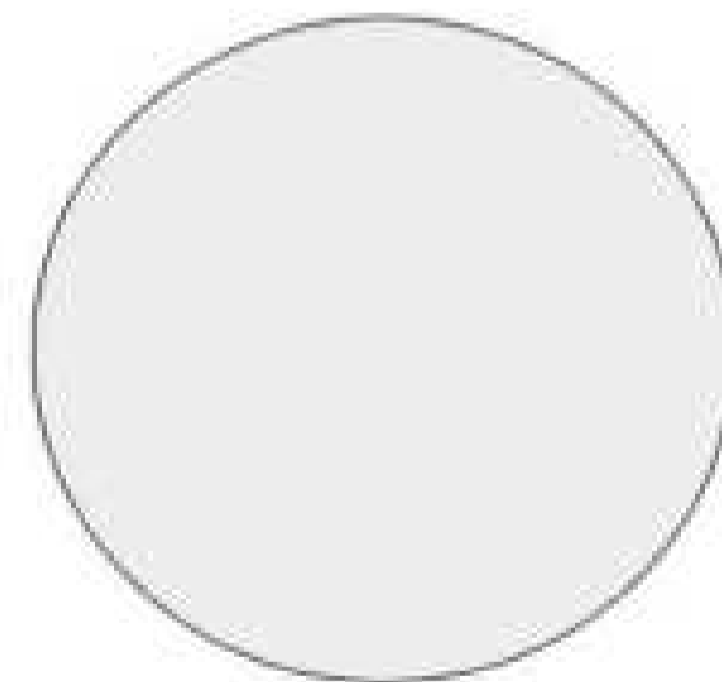

SOFT BEYAZ / SOFT WHITE
POLİMERİK / POLYMERIC

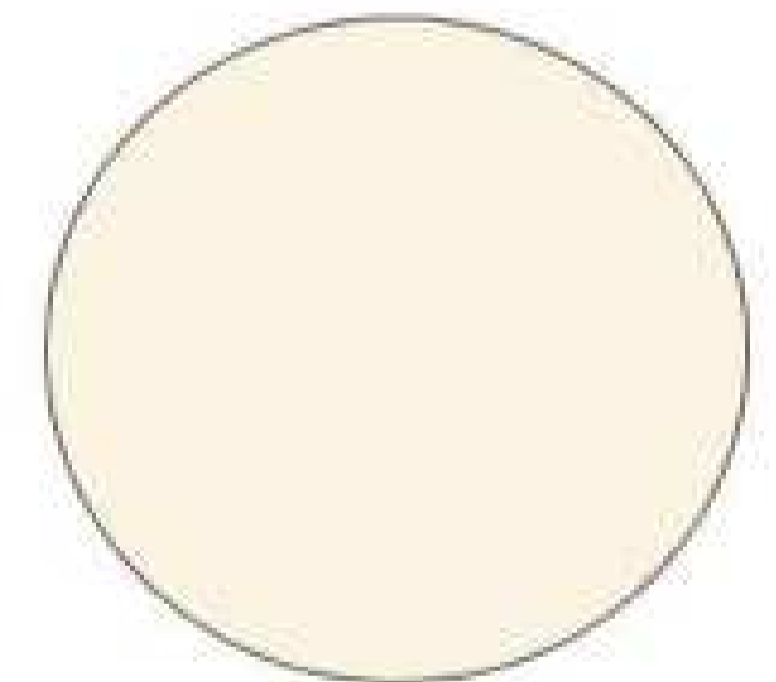

KREM / CREAM
POLİMERİK / POLYMERIC

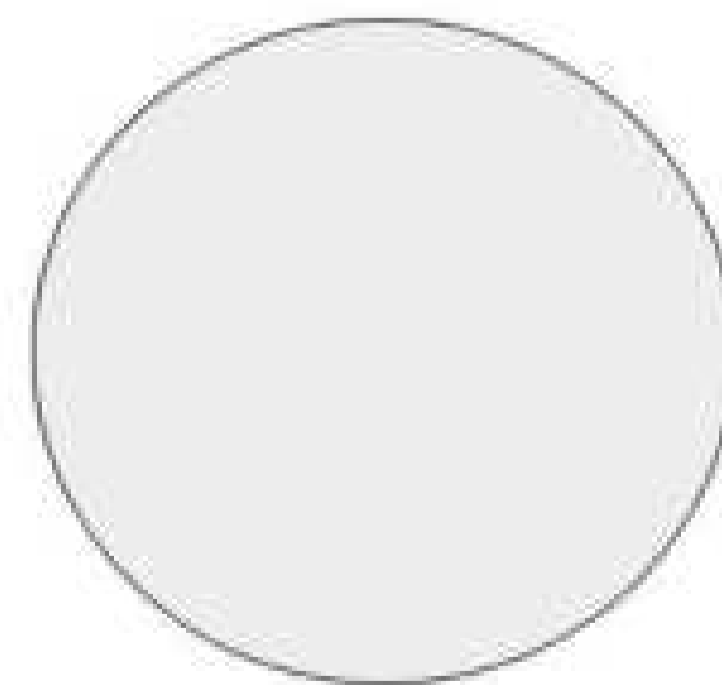

BEYAZ / WHITE
LAKE / LACQUER

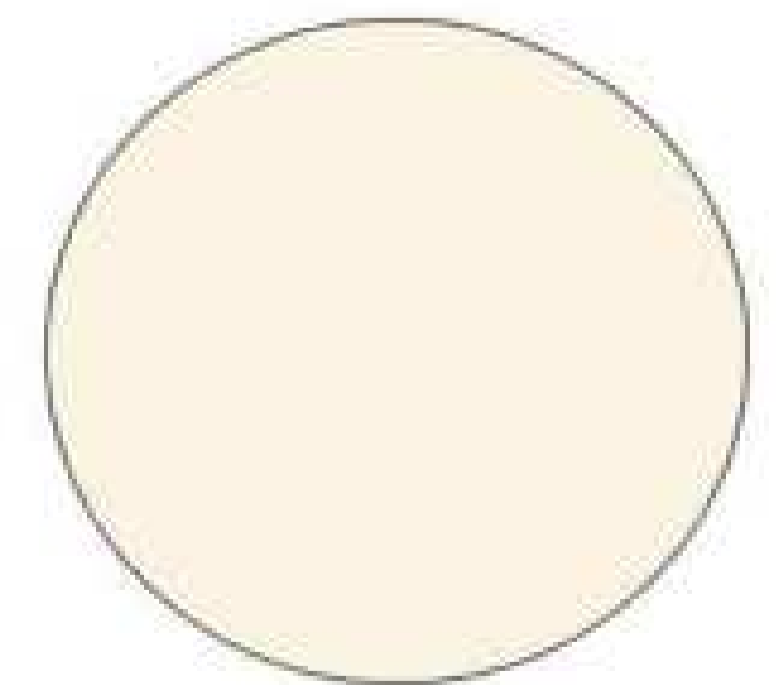

FİLDİŞİ / IVORY
LAKE / LACQUER

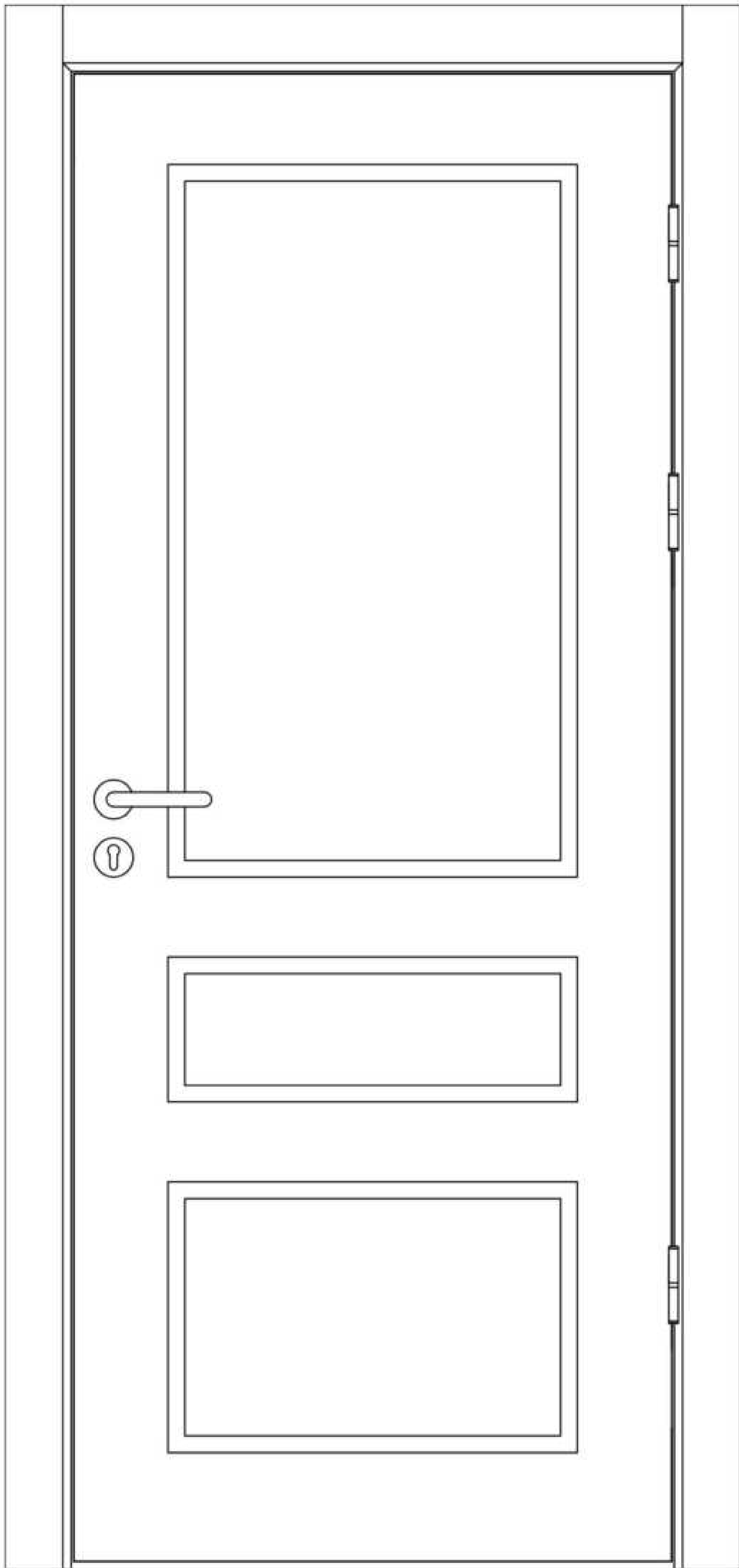

0 9 8

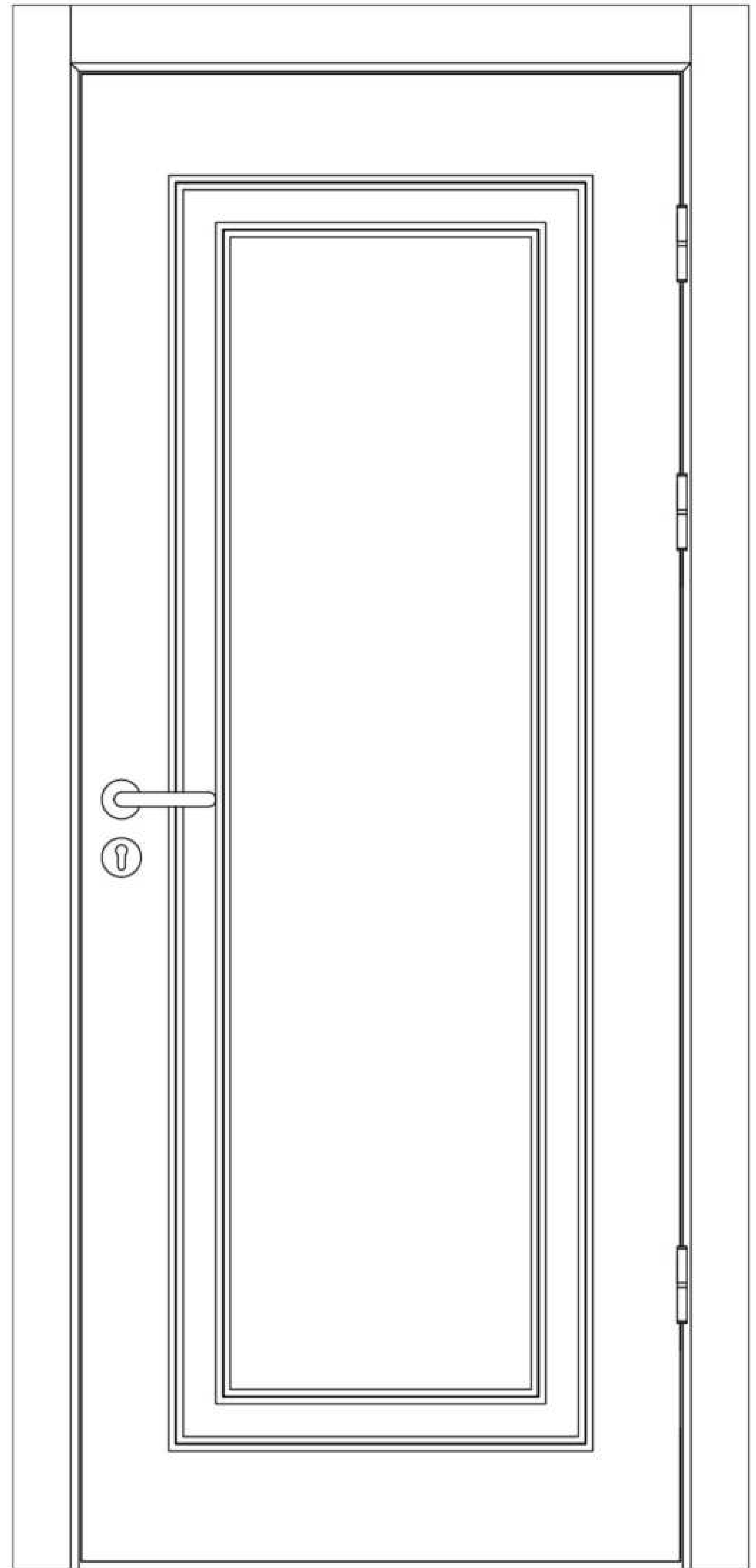

7 0 7

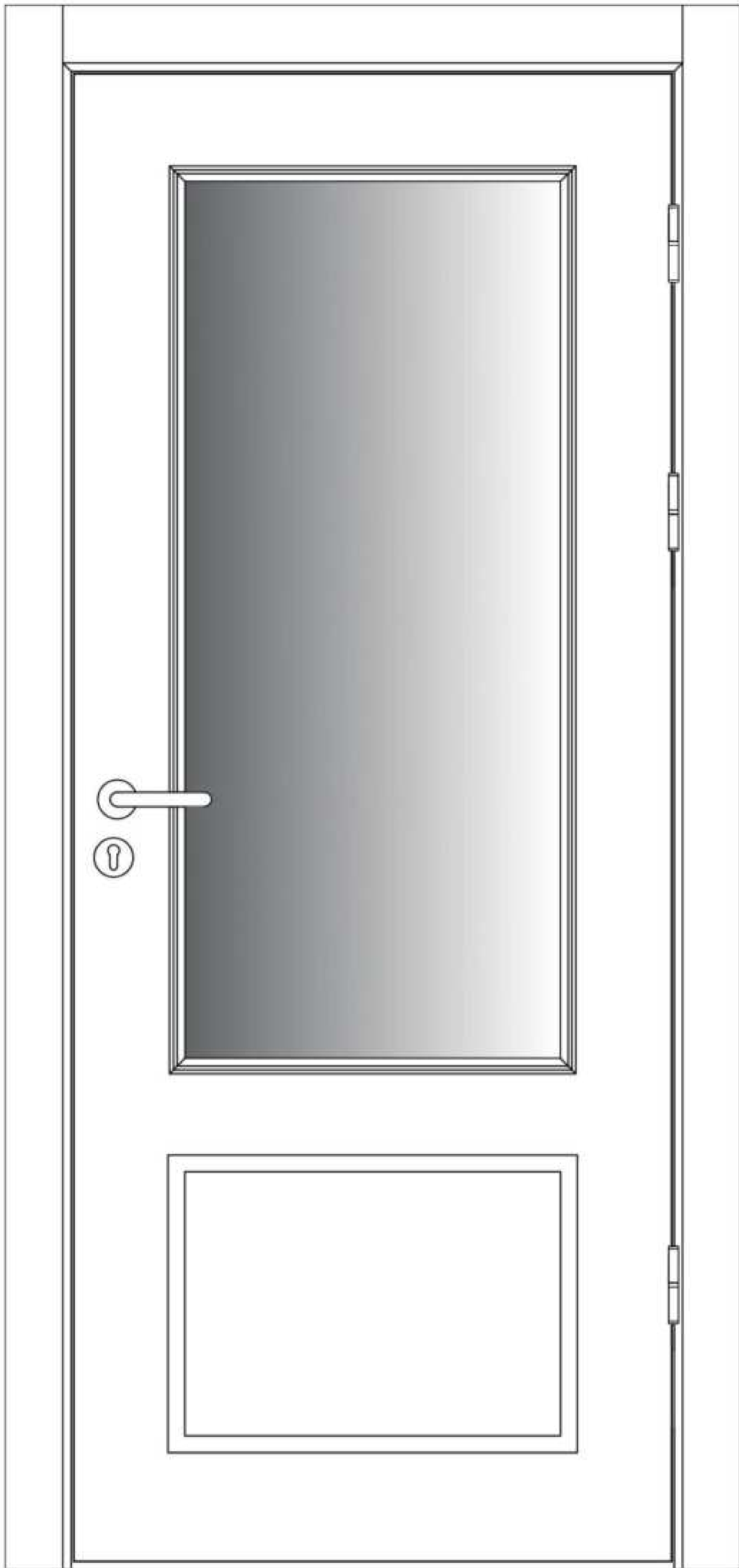

C018-G

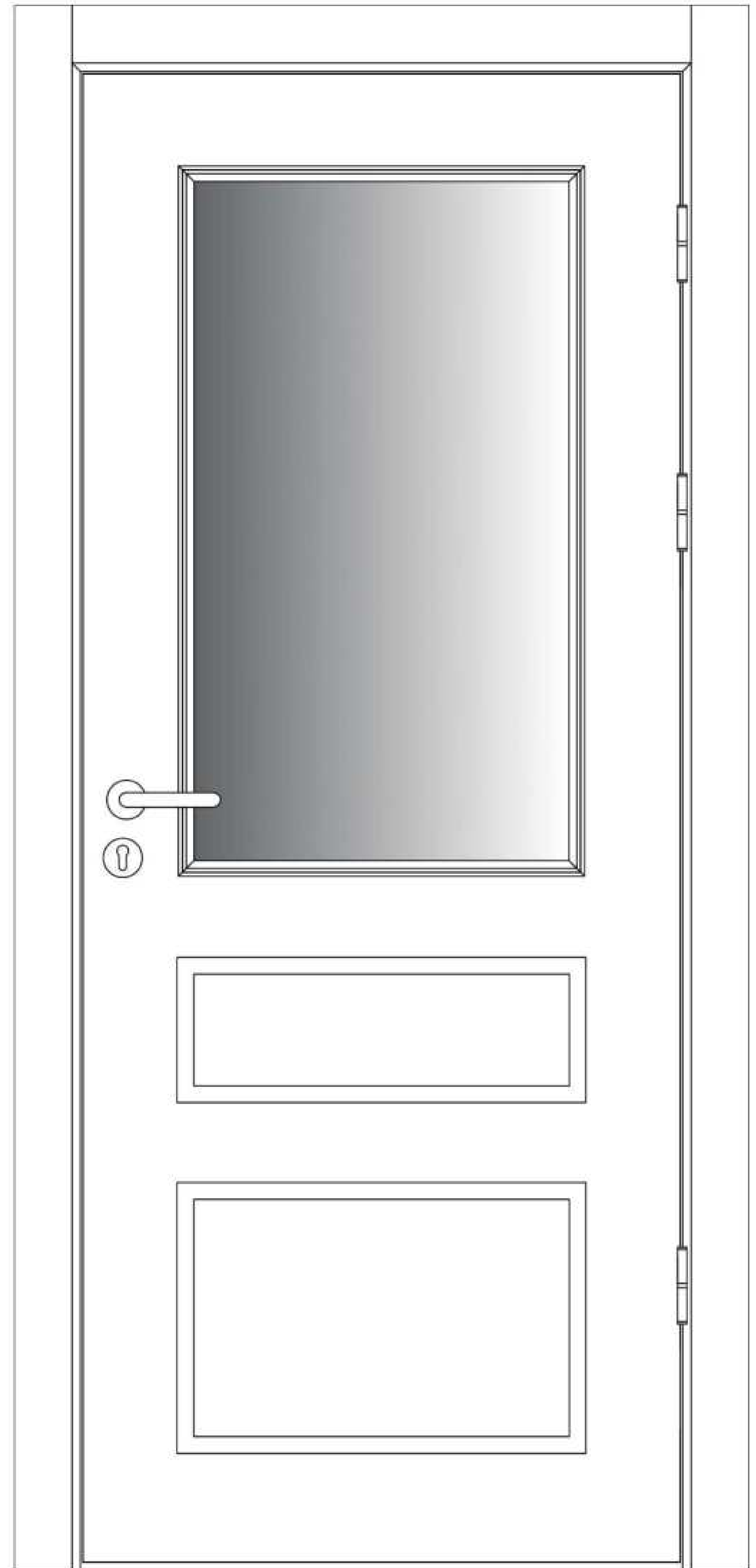

C098-G

FRAME

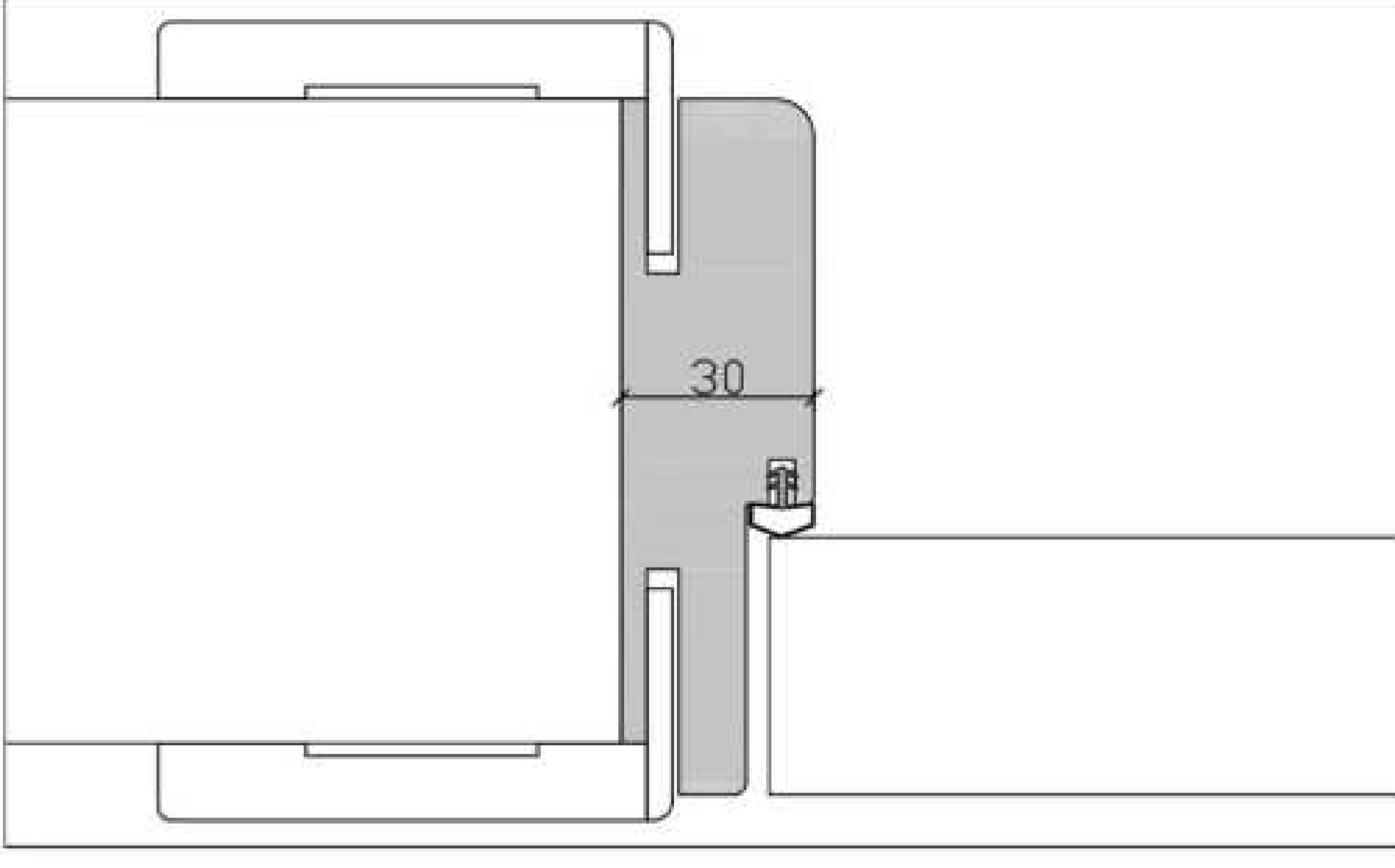

LEAF

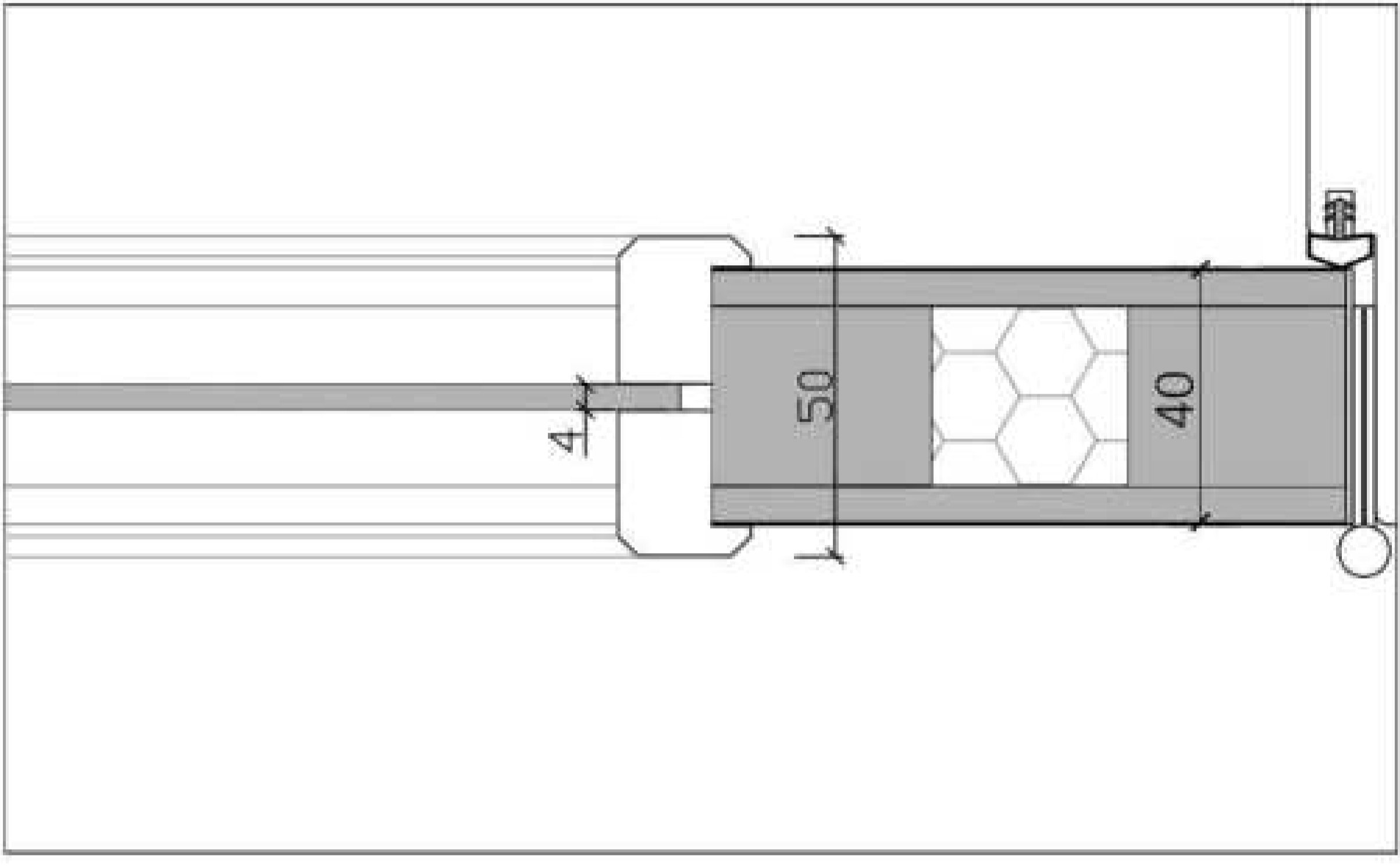

ARCHITRAVE

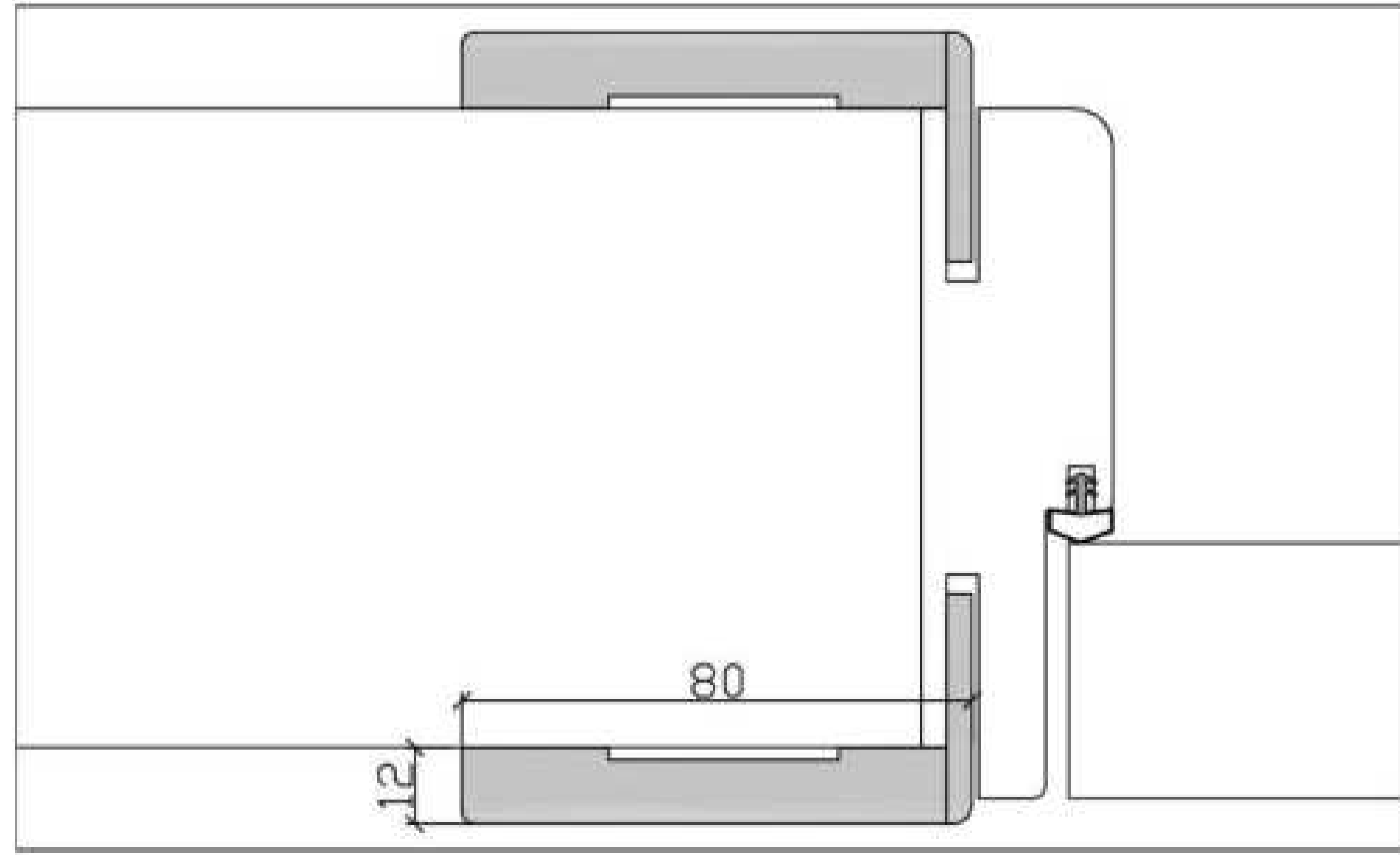

HARDWARE

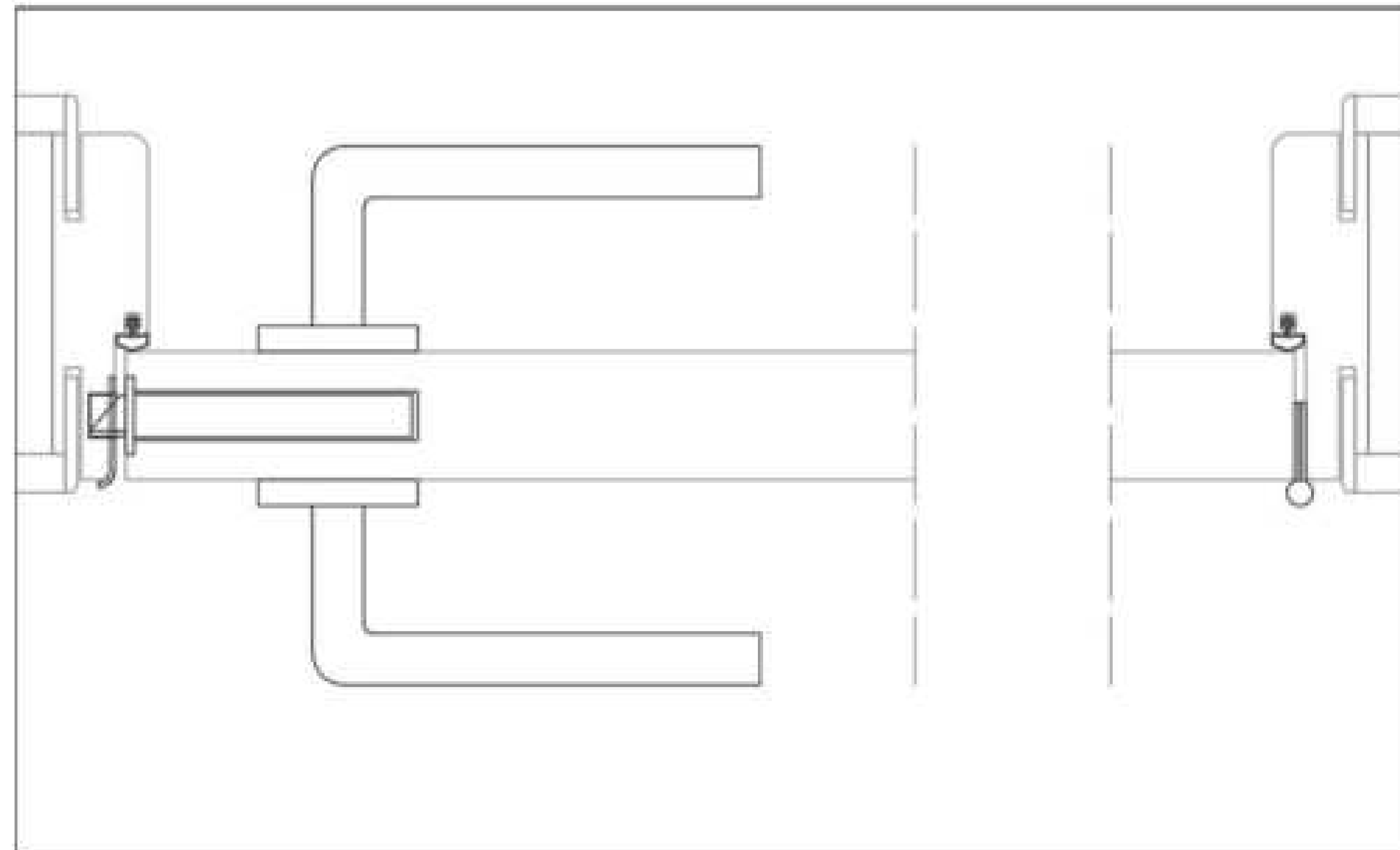

KASA

Aden serisi kapılarında, 30 mm MDF kasa standart olarak sunulur. Yüzeyler seçilen malzeme ve renkte tanımlanır. Kasa montaj öncesinde yerinde birleştirilir ve duvarla arasında kalan boşlukta 15 mm poliüretan dolgu malzemesi kullanılır. Duvar derinliğine göre farklı ölçü seçenekleri sunulmaktadır.

In Aden series doors, 30 mm MDF frame provided as standard. Surface defined with the selected material. Frame is assembled in the place before installation and the space between wall and frame fills with 15 mm polyurethane foam. Different size options are offered according to the depth of the wall.

KANAT

Tüm kapı modellerinde standart olarak 12mm kalınlığında 80 mm genişliğinde düz model mdf pervaz kullanılır. Pervaz yüzeyi kapı yüzeyi ile aynı malzeme/renk seçeneklerinden tercih edilir. Kapı üst başlık pervazı yan pervazlar arasına yerleştirilerek 90 derece köşe birleşim detayı sağlanmış olur.

Leafes are produced by fir wood door carcass with MDF surfaces on it and coated/painted with selected material. Total leaf thickness is 40 mm and side surfaces covered with edge band. Filler honeycomb is applied to the inner space.

PERVAZ

Tüm modellerde standart olarak 12 mm kalınlığında, 80 mm genişliğinde MDF pervaz çerçeveleri kullanılır. Yüzeyler seçilen malzemede tanımlanır. Pervazlar, kasa içerisine geçirilerek sabitlenir. Köşe pervaz 90° detayında birleştirilir. Yatay pervaz, dikey pervazların arasında konumlanır.

Architraves are standard in all models with 12 mm thickness and 80 mm MDF. Surfaces defined with the selected material. Arches slides inside of the frame and fixed. Upper corners joins together on 90° detail. Horizontal architrave is placed between vertical architraves.

AKSESUAR

Kapı temel elemanlarına ek olarak üçlü menteşe seti, kilit seti, kilit karşılığı ve model ile uyumlu fitil kapı seti ile birlikte gelir. Kol seti yuvası ise seçilen ilgili aralıktaki modele göre açılır ve ayrıca uygulanır. Opsiyonel olarak standart Aden kol setini de ürününüze ekleyebilirsiniz.

In addition to the basic elements of door, triple hinge set, lock counterpart and seal (compatible with door), comes with the product. Handle set slots opens according to model and applied separately. Optionally, you can add standard Aden handle set to your product.



C108-G5
PONTE



707
LUX



710
PONTE



420
PONTE

ÖLÇÜ KILAVUZU

<p>EN WIDTH (CM)</p> <p>70</p> <p>80</p> <p>90</p>	
<p>BOY HEIGHT (CM)</p> <p>205</p> <p>210</p>	
<p>KASA FRAME (CM)</p> <p>10 (11-12)</p> <p>13 (14-15)</p> <p>16 (17-18)</p> <p>19 (20-21)</p>	

EN
WIDTH
(CM)

130

Yavru K.
One &
Half L.

180

Çift K.
Double L.

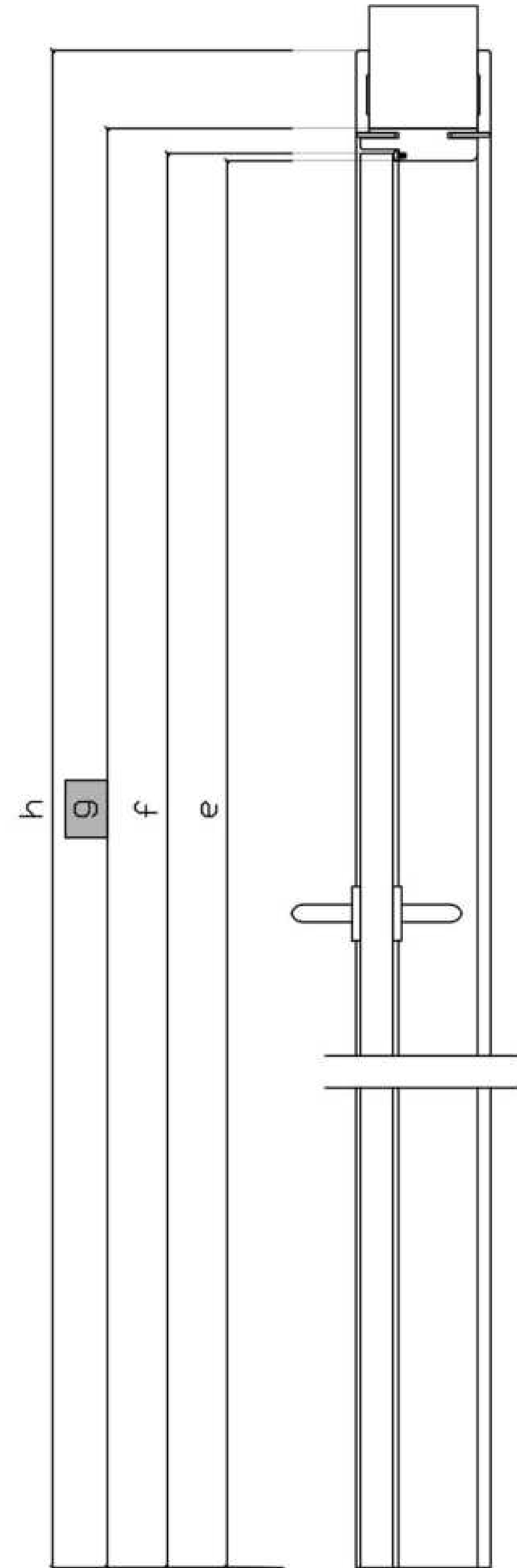
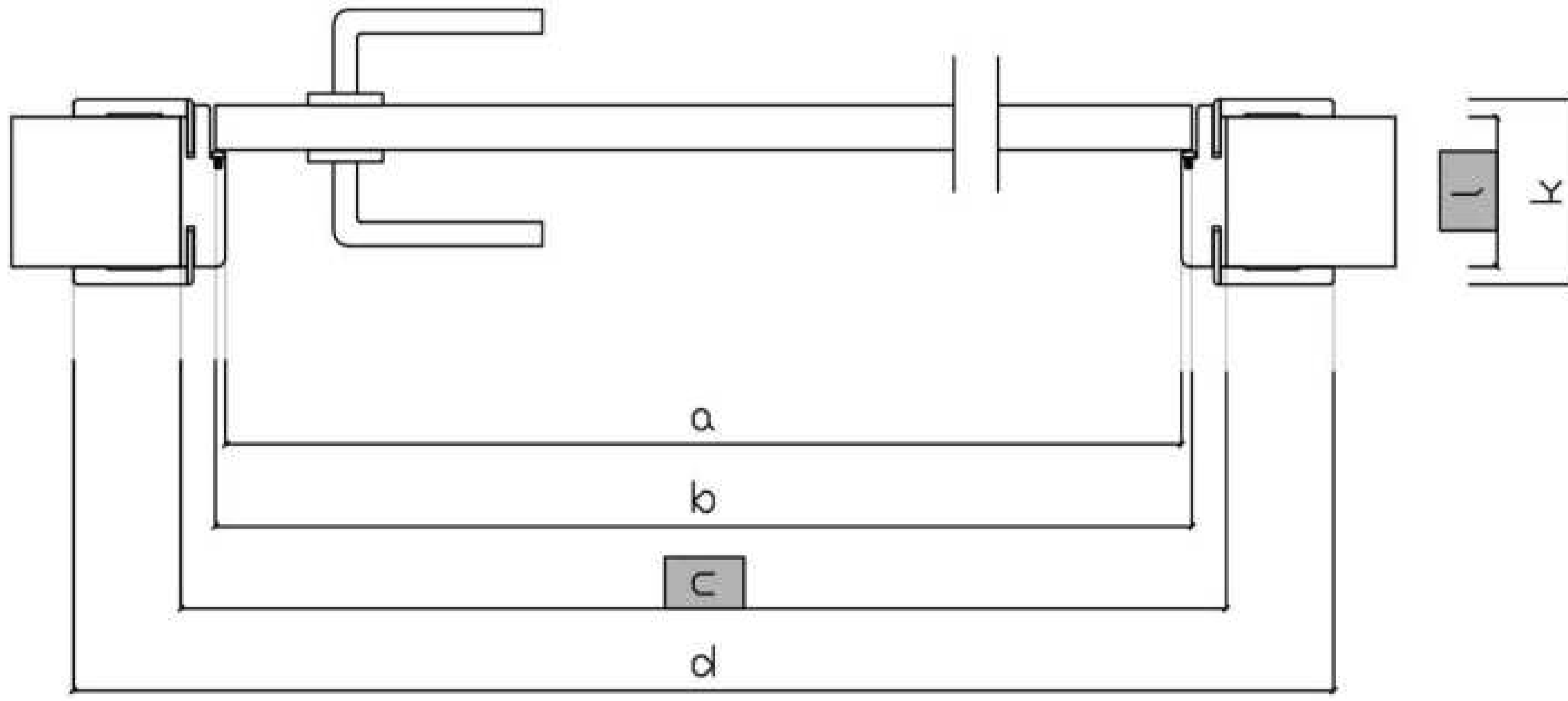
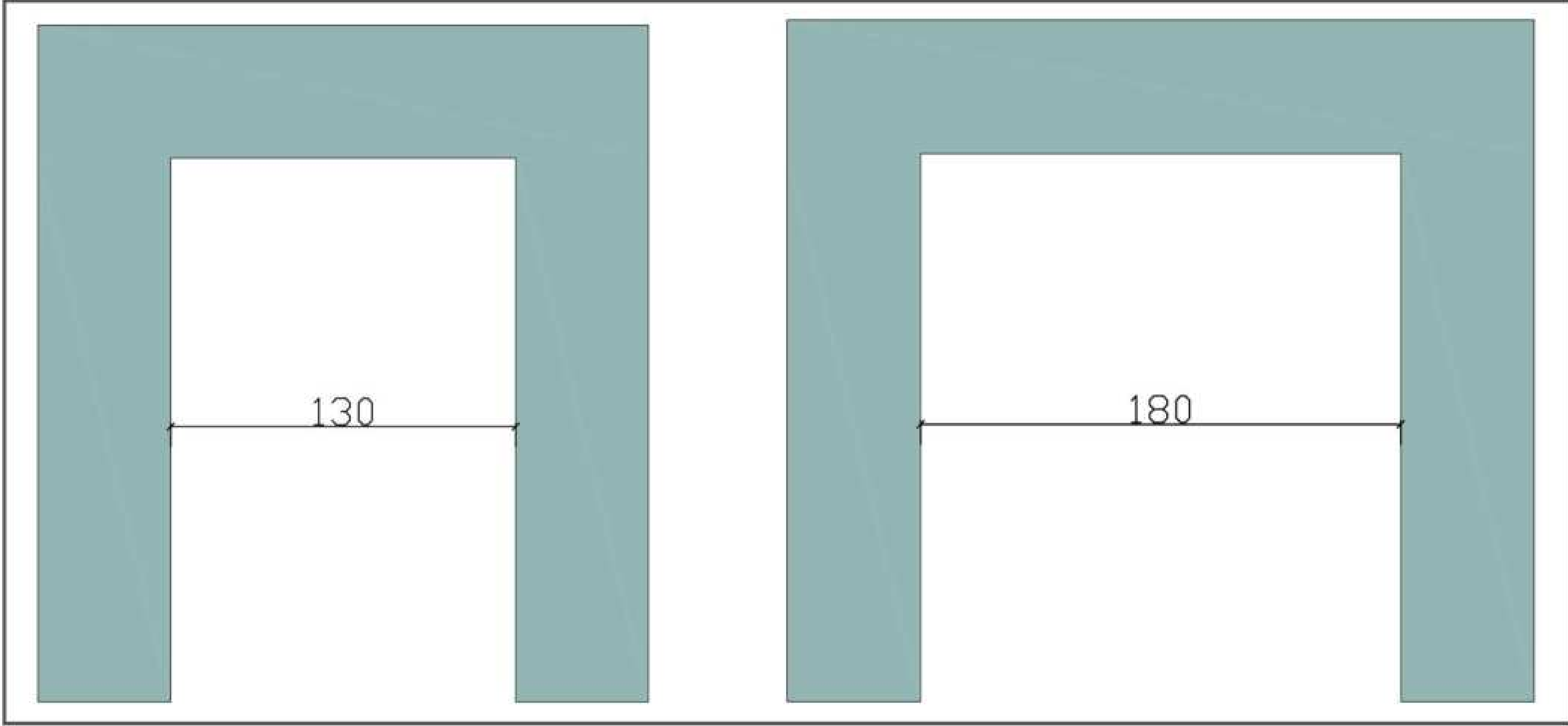

a-e Geçiş / Pass c-g Boşluk / Space l Derinlik / Depth
b-f Kanat / Leaf d-h Toplam / Total k T. Derinlik / T. Depth

Tip/Type	a	b	c	d	e	f	g	h	l	k
	610	624	700	814	2005	2020	2050	2107	100	124
	710	724	800	914	2055	2070	2100	2157	130	154
	810	824	900	1014	2005	2020	2050	2107	160	184
	1210	1224	1300	1414	2005	2020	2050	2107	190	214
	1710	1724	1800	1914	2055	2070	2100	2157		



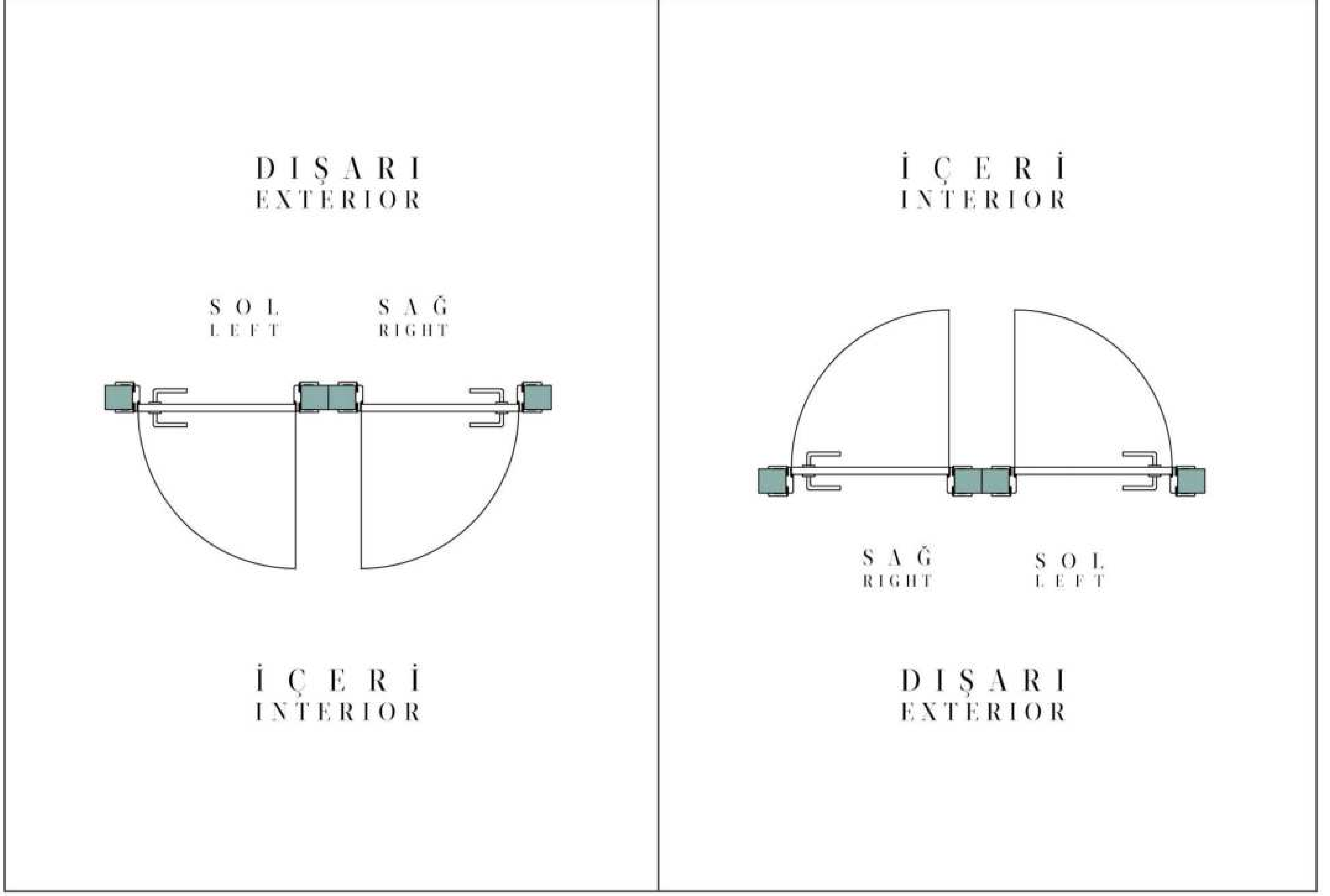

DiĞER ÖLÇÜLER / OTHER MEASURES

KAPI YÖNÜ / DOOR DIRECTION

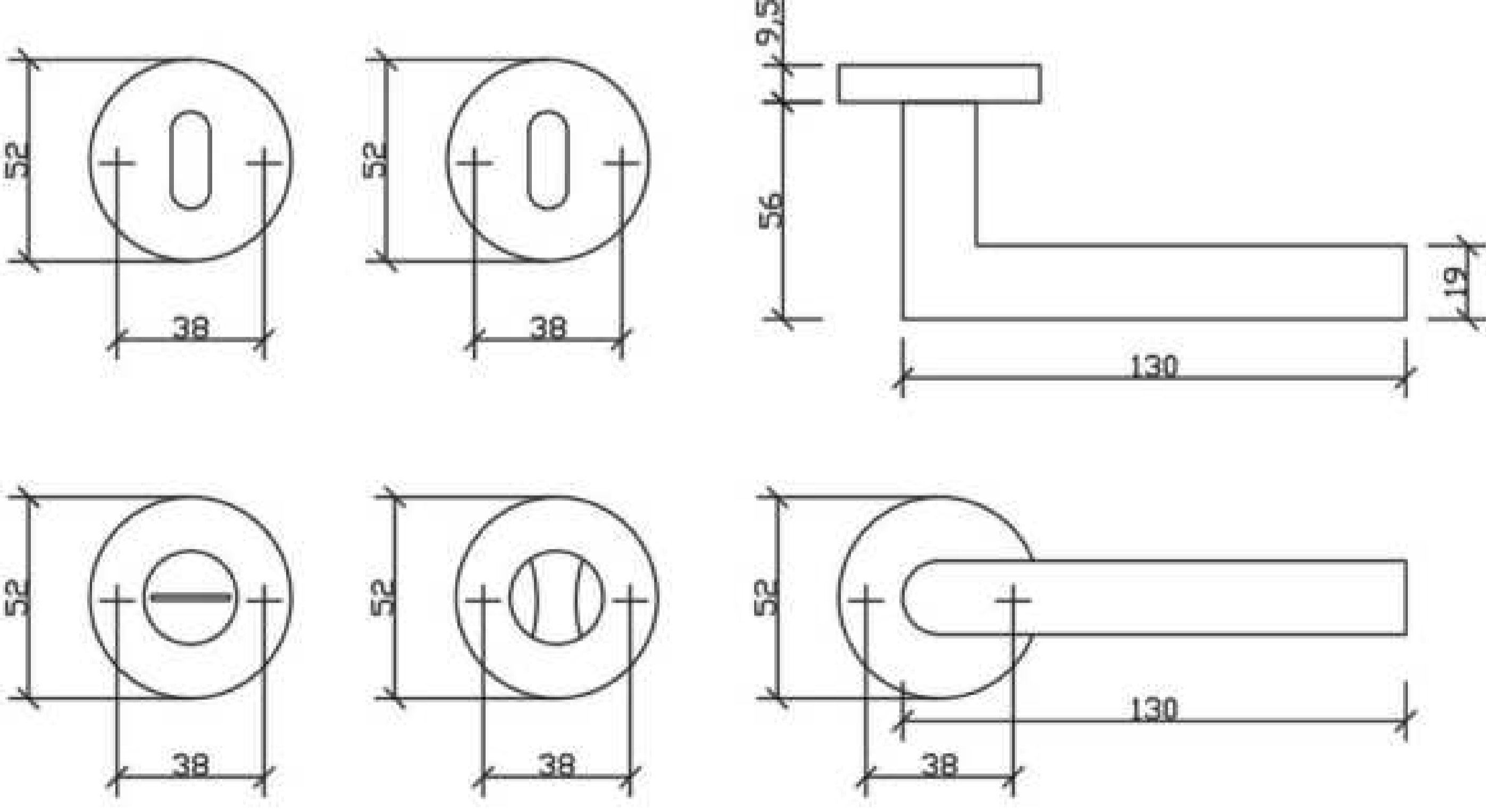

DONANIM / HARDWARE



AÇIKLAMA DESCRIPTION	TEKNİK TECHNIC	BANYO TİPİ BATHROOM TYPE	S. ODA TİPİ S. ROOM TYPE
<p>Paslanmaz çelik Aden kol setleri, silindirik yapısı ile konforlu ve zarif, minimal tasarımı sayesinde de tüm Aden modelleri ile uyumludur. (Model Kodu : KK402)</p> <p>Stainless steel Aden handle sets are compatible with all Aden models with its minimal design, comfortable with its cylindrical structure. (Model Code : KK402)</p>			
			
<p>ADEN STANDART KOL SETİ / ADEN STANDARD HANDLE SET</p>			

RENK PALETİ

POLYMERIC Polimerik Lamine Renk Kaplama Polymeric Laminated Color Coating	 <p>S. BEYAZ / S. WHITE</p>
	 <p>KREM / CREAM</p>
	 <p>TAŞ GRİ / S. GREY</p>

LACQUER İpek Mat Lake Boya Silk Matte Lacquer Paint	 <p>BEYAZ / WHITE</p>
	 <p>FİLDİŞİ / IVORY</p>

 <p>AÇIK MEŞE / L. OAK</p>	<p>Polymeric Laminated Wood Coating</p>
 <p>TİK / TEAK</p>	<p>POLYMERIC</p>
 <p>ÇINAR / PLANE</p>	<p>Polimerik Lamine Ağaç Kaplama</p>

ADEN



Line

Bu katalog yalnızca alıcının kullanımı içindir. Bütün bölümleri ve her hakkı Dortek'e aittir. Kataloğun tekrar basımı, kısmi dahi olsa şekillerinin kopyalanması, çizilmesi ve katalog tasarımının kopyalanması yasaktır. Bu katalogdaki teknik tanımlar, ölçüler ve çizimler bağlayıcı değildir. Dortek, her tür ölçü, kaplama, donanım ve aksesuar değiştirme hakkını saklı tutar. Tasarım aşamasında güncel detayların teyit edilmesi gerekir. Sipariş aşamasında, sadece Dortek güncel fiyat listesinde yer alan kod bilgileri değerlendirmeye alınır. Baskıda oluşabilecek hatalardan dolayı sorumluluk kabul edilmez.

Telif hakları Dortek Kapı San. ve Tic. A.Ş.'ye aittir. Tüm hakları saklıdır.

2021

ADEN



Line

This catalog is only for the use of the buyer. All sections and rights belong to Dortek. It is strictly forbidden to reproduce, copy, draw the figures even partially and to copy the catalog's design. The technical specifications, measures and drawings shall not be binding. Dortek reserves the right to change any. During the ordering, the code details given in Dortek's current price list are considered. All deliveries are performed according to the sales conditions of Dortek. No responsibility is assumed for any mistake occurring in the printing.



NOTE

ADEN_{line}



NOTE

ADEN_{line}



DORTEK KAPI SAN. VE TİC. A.Ş.

Merdivenköy Mah. Yumurtacı Abdi
Bey Cd, Dikyol Sk. No:2 B Blok Kat:19,
34732 KADIKÖY / İSTANBUL

Ofis Telefon: +90 216 412 40 35

Fax: +90 216 412 27 72

Email: info@dortek.com.tr

Web: www.dortek.com.tr

